



WOOD FLOORS & ACCESSORIES

Truly Bespoke Wood Floors

TRADE
PRICE
LIST

FEBRUARY
2020

MADE IN
BRITAIN 

www.wfa.uk.net • **CALL 020 8501 6730** • info@wfa.uk.net

- ✔ Extensive stock of FSC European engineered flooring
- ✔ State of the art texturing and prefinishing department
- ✔ Dedicated sample lab with experienced colour technicians
- ✔ Leading brands of quality accessories
- ✔ Next day Nationwide deliveries
- ✔ Same day London deliveries
- ✔ Established in 1999





WOOD FLOORS & ACCESSORIES



EXTENDED ORDER CUT OFF TIME

All orders for stock items placed before 3pm will be available for next day delivery.

OUR TRADE COUNTER IS OPEN

7.00AM - 5.00PM MONDAY TO THURSDAY

LAST ORDERS PROCESSED AT 4.30PM

7.00AM - 4.30PM FRIDAY

LAST ORDERS PROCESSED AT 4.00PM

WE DELIVER 6 DAYS A WEEK *subject to delivery terms

For sales call 020 8501 6730

info@wfa.uk.net • www.wfa.uk.net

Payment methods: Cash, Visa, Mastercard, Debit Cards, BACS & Monthly Credit Account (Subject to terms & approval)
Please note we do not accept American Express or Cheques.

We are certified to FSC® & PEFC™ standards and can provide full chain of custody for projects and the certified stock items identified in this catalogue.



This logo will identify the FSC-certified products throughout the price list.

DELIVERY TERMS - for UK Mainland
on all orders placed before 3pm

WOOD FLOORING PRICES

Next Day Service - Business Hours **FREE**

on orders over £500 +VAT

Next Day Service - Business Hours **£65.00** +VAT

on orders below £500 +VAT

Next Day - Before 10.30am* **£80.00** +VAT

Saturday - Before 1.00pm* **£95.00** +VAT

MACHINERY & ACCESSORIES PRICES

Next Day Service - Business Hours **FREE**

on orders over £150 +VAT

Next Day Service - Business Hours **£10.00** +VAT

on orders below £150 +VAT

Next Day - Before 10.30am **£30.00** +VAT

Next Day - Before 12.00pm **£25.00** +VAT

Saturday - Before 10.00am **£40.00** +VAT

PLEASE NOTE: Reclaimed Floorboards and various products within the **Accessories** section are excluded from the above pricing structure due to their size, weight or flammability . *See inside back cover.*

*This is subject to your local depots delivery service.



The mark of responsible forestry



FOLLOW US ON



All prices are correct at the time of going to press and are subject to VAT at the current rate. Please note that colour representation is not entirely accurate and is for guide purposes only, call to order free samples. If you no longer wish to receive marketing information from WFA Limited please contact by phone or email.



Stock

With an extensive stock of flooring, accessories and the leading brands in tools, we offer a nationwide next day delivery with optional timed services.

Our **33,000 Sq Ft premises** is conveniently located minutes from the A127/A12/A118 and near Junction 28 of the M25 allowing us to also offer same day deliveries into London.



Service

Our trade counter and sales team are available Monday to Friday to offer expert advice and arrange your orders for prompt delivery to site or collection from our warehouse.

With a fully stocked sample department, hand samples can be sent **Free of charge** directly to your customer within 24 hours.



Meet the team

Since 2000 we have built a very strong team of experienced staff who have helped us to achieve an excellent reputation within the industry for the service and quality products we offer. Many have worked for the company for over 10 years and understand our values of honesty, integrity and reliability.

WHAT'S **NEW** FOR 2020

Every new year bring's with it **NEW** products from us as we strive to evolve within the industry. Listening to what you and your customers need we work hard in supplying this to you! Along with **OUR NEW** and exciting flooring options our suppliers are also continuously looking at producing new ways of making your lives easier.

Across this spread are a just few of the aforementioned items that we have added to our price list...



CALLISTO *collection*

Our Callisto Collection has been a great success so far and is new to this price list, available in 6 great colours **see pages 8 & 9.**

MADE IN BRITAIN

ORDER YOUR **FREE** SAMPLES TODAY

WAKOL



+



=

Ready-to-use 1-component MS primer for absorbent and non-absorbent subfloors, **see page 125.**

Dry in 1 hour - ready to glue or level with D3045 & Z715.



NEW
see pages
10 & 11

Reclaimed Oak in Plank, Herringbone and Chevron, so beautifully full of character in 4 choices of finish.

- Unfinished •
- Natural Oil •
- Light Smoked and Oiled •
- Dark Smoked and Oiled •



Square edge stair nosing for 15/20mm flooring **see page 117.**

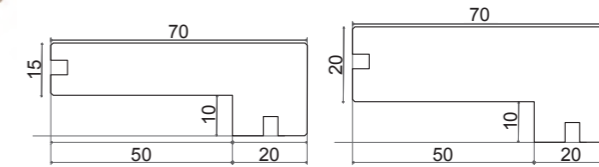

NEW Callisto Collection	8-9
NEW Genuine Reclaimed Oak	10-11
London Collection	12-13
Stability Planks Unfinished	14-15
Stability Design Blocks and Chevrons	16-17
Stability Design Mansion Weave, Cube, Hexagon	18-19
and Continuous Versailles	
Stability Design Panels	20-23
Truly Bespoke Wood Floors - TBWF	24-25
TBWF The Laboratory	26
TBWF Stairs and Mouldings	27
TBWF Grading, Tumbling and Smoking	28-31
TBWF Core Range	32-45
Bespoke Flooring	46-47

Kährs	48-49
Elegance	50-51
End Grain	52-53
Mosaic Panels	54-55
Parquet Battens	56-57
Parquet Strip	58-59
Parquet Panels	60-61
Parquet Borders	62-63
Parquet Motifs	64-65
Solid T&G Wood Strip Unfinished	66-67
Solid T&G Wood Blocks Unfinished	68-69
Tumbled Blocks and Battens	70-71
Reclaimed Floorboards	72

Air Nailers and Staplers	73
Bona Sanding Machines	74-76
Compressors	77
Diamabrush	78
Fidbox and Hmbox	79
Fein Power Tools	80
Surebuild	81

Festo Power Tools	82-89
Hand Tools	90-92
Maxvac	93
Leica Laser Measure	94
LCD Thermometer and Hygrometer	95
Moisture Meters - Protimeter	96
Moisture Meters - Tramex	97

Abrasives	98-102
Adhesives and Applicators	103-107
CMS Danskin Cradles, Battens and Regupol	108-109
Fillers	110-111
Fixings	112-115
Hardwood Mouldings	116-117
Lacquers	118-123
Levelling, Primers and DPM's	124-125

Matting	126
Oils and Stains	127-131
Plywood, Hardboard and Chipboard	132
Protection Products	133
Sanding and Polishing Accessories	134-137
Trims (Metal)	138
Underfloor Heating	139
Underlays	140-141

Bona Lacquer and Oil Maintenance	142-143
Junckers Lacquer and Oil Maintenance	144
Osmo Oil Maintenance	144-145

Lobacare® Lacquer Maintenance	146
Felt Pads	147
Terms and Conditions	Inside Back Cover

CALLISTO *collection*

**MADE IN
BRITAIN**

- **NEW** six colour range **PURO, PRIMO, NERO, PIETRA, FLAVIA & LUNA**
- Produced in Europe
- 100% FSC European Oak Rustic

Profile: T&G, ends matched, Planks 2 sided bevel, Herringbone 4 sided bevel

Thickness: 12/3mm

Finish: UV oiled matt

Installation: Glued

Length Specification: Planks 180 x 600 – 2400mm, Herringbone 120 x 600mm

ORDER
YOUR **FREE**
SAMPLES
TODAY



Plank **PURO** Euro Oak Rustic
UV Oiled Matt
180 x 12/3mm



Plank **PRIMO** Euro Oak Rustic
UV Oiled Matt
180 x 12/3mm



Plank **NERO** Euro Oak Rustic
UV Oiled Matt
180 x 12/3mm



Plank **PIETRA** Euro Oak Rustic
UV Oiled Matt
180 x 12/3mm



Plank **FLAVIA** Euro Oak Rustic
UV Oiled Matt
180 x 12/3mm



Plank **LUNA** Euro Oak Rustic
UV Oiled Matt
180 x 12/3mm



Herringbone **PURO** Euro Oak Rustic
UV Oiled Matt
600 x 120 x 12/3mm

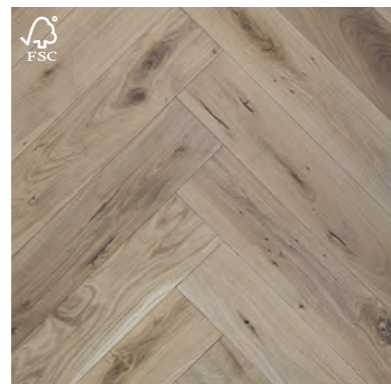

Herringbone **PRIMO** Euro Oak Rustic
UV Oiled Matt
600 x 120 x 12/3mm



Herringbone **NERO** Euro Oak Rustic
UV Oiled Matt
600 x 120 x 12/3mm

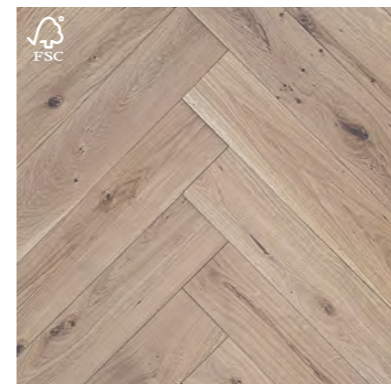

Herringbone **PIETRA** Euro Oak Rustic
UV Oiled Matt
600 x 120 x 12/3mm



Herringbone **FLAVIA** Euro Oak Rustic
UV Oiled Matt
600 x 120 x 12/3mm

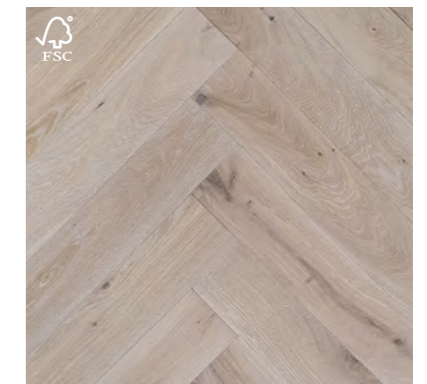

Herringbone **LUNA** Euro Oak Rustic
UV Oiled Matt
600 x 120 x 12/3mm

GENUINE RECLAIMED OAK

- Our genuine reclaimed products are produced from 60-100 year old beams reclaimed from old buildings in France and Germany.
- Open splits, knots, holes and dead worm holes are filled with black filler and the surface heavy brushed to leave some of the filler lower and emphasise the appearance of these features.
- Original bandsawn and planer marks plus irregular edges may be visible and add to the characteristics of a reclaimed floor.

Profile: Planks and Chevron 2 sided micro bevelled, Herringbone 4 sided micro bevelled
Thickness: 20.5/5.5mm
Finish: Unfinished / natural oiled / light smoked & oiled / dark smoked & oiled
Dimensions: Planks* 215 - 225 x 600 - 2400mm
 Herringbone 100 x 500mm
 Chevron 120 x 600mm

* subject to current stock
 All produced to order 4 - 6 weeks



Natural Oiled



Irregular edges



Bandsawn



Partially filled cracks



Partially filled knots



Woodworm[†] and sapwood



Plank Rustic Unfinished

20.5/5.5 x 215 - 225mm



Plank Rustic Natural Oiled

20.5/5.5 x 215 - 225mm



Plank Rustic Light Smoked & Oiled

20.5/5.5 x 215 - 225mm

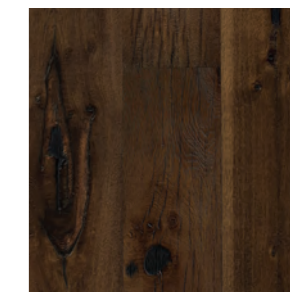

Plank Rustic Dark Smoked & Oiled

20.5/5.5 x 215 - 225mm

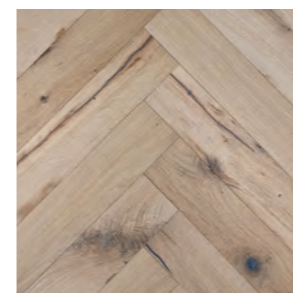

Herringbone Rustic Unfinished

20.5/5.5 x 100 x 500mm

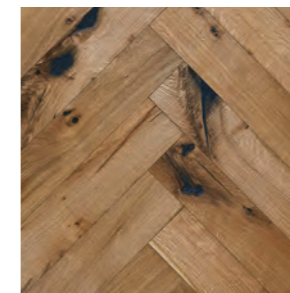

Herringbone Rustic Natural Oiled

20.5/5.5 x 100 x 500mm



Herringbone Rustic Light Smoked & Oiled

20.5/5.5 x 100 x 500mm



Herringbone Rustic Dark Smoked & Oiled

20.5/5.5 x 100 x 500mm

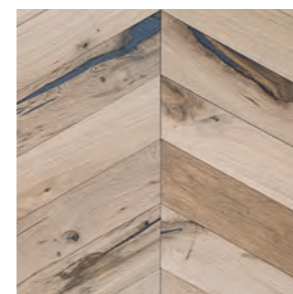

45/60° Chevron Rustic Unfinished

20.5/5.5 x 120 x 600mm

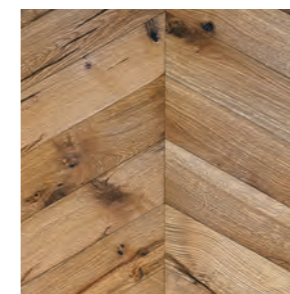

45/60° Chevron Rustic Natural Oiled

20.5/5.5 x 100 x 500mm

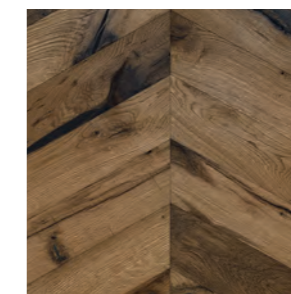

45/60° Chevron Rustic Light Smoked & Oiled

20.5/5.5 x 100 x 500mm

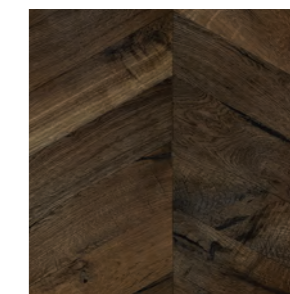

45/60° Chevron Rustic Dark Smoked & Oiled

20.5/5.5 x 100 x 500mm

LONDON COLLECTION

- Produced in Europe
- 100% FSC European Oak
- Project Range – Produced to order - 4 – 8 weeks
- Bespoke range of colours available

Profile: T&G, ends matched, micro bevelled or square edged

Thickness: 10/4mm (6mm Birch plywood & 4mm Oak)

Finish: UV oiled or lacquered

Installation: Glued

Length Specification: Planks 1000 – 1200mm



BF526

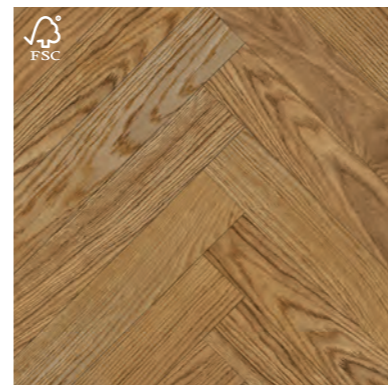

Herringbone Prime Lacquered/Oiled
490 x 70 x 10/4mm
500 x 90 x 10/4mm



Chevron Prime Lacquered/Oiled
500 x 90 x 10/4mm

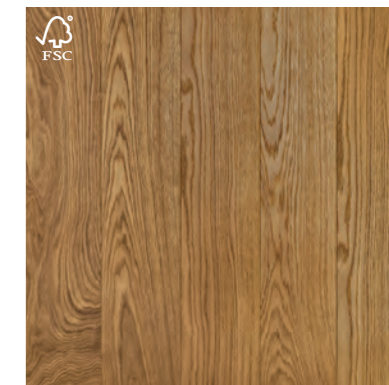

Plank Prime Lacquered/Oiled
120 x 10/4mm



Herringbone Rustic Lacquered/Oiled
490 x 70 x 10/4mm
500 x 90 x 10/4mm



Chevron Rustic Lacquered/Oiled
500 x 90 x 10/4mm



Plank Rustic Lacquered/Oiled
120 x 10/4mm

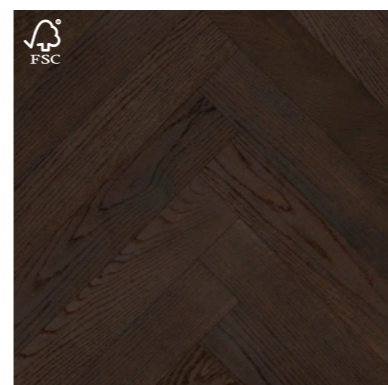

Herringbone Prime Fumed Lacquered/Oiled
490 x 70 x 10/4mm
500 x 90 x 10/4mm

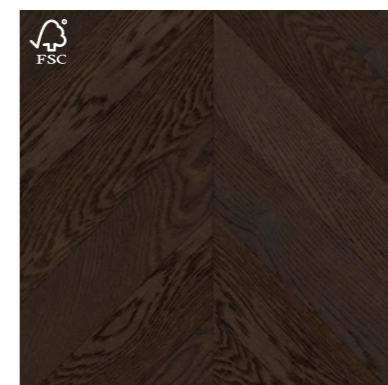

Chevron Prime Fumed Lacquered/Oiled
500 x 90 x 10/4mm

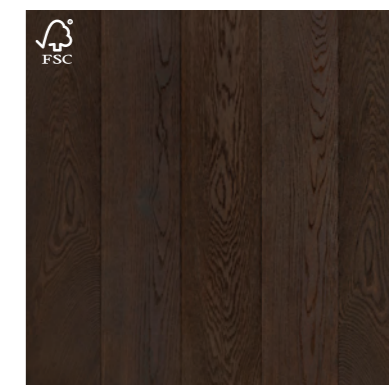

Plank Prime Fumed Lacquered/Oiled
120 x 10/4mm



- Produced in Europe

Profile: T&G, ends matched and 2 sided micro bevelled edges

Thickness: 12/3mm, 15/4mm and 20/6mm

Finish: Unfinished/lacquered

Installation: Secret nailed/glued/float

Length Specification: Random lengths 1400 – 2400mm for 20mm and 600 – 2200mm for 12/15mm

NOTE Square Edged Profile: 140/180/220/260 x 20mm Rustic in stock. Other sizes produced to order

* Produced to order - Wenge/Douglas Fir/American Black Walnut 3 – 4 weeks



BF920



Euro Oak Rustic Unfinished

180 x 12/3mm



Euro Oak Prime Unfinished

140 x 15/4mm
180 x 15/4mm
220 x 15/4mm



Euro Oak Rustic Unfinished

140 x 15/4mm
180 x 15/4mm
220 x 15/4mm



Euro Oak Rustic Satin Lacquered

180 x 20/6mm

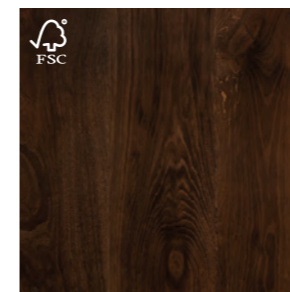

Euro Oak Rustic 'Fumed' Unfinished

180 x 20/6mm



Euro Oak Prime 'Fumed' Unfinished

180 x 20/6mm
220 x 20/6mm
260 x 20/6mm



Euro Oak Rustic Unfinished

140 x 20/6mm
180 x 20/6mm
220 x 20/6mm
260 x 20/6mm
300 x 20/6mm



Euro Oak Prime Unfinished

140 x 20/6mm
160 x 20/6mm
180 x 20/6mm
200 x 20/6mm
220 x 20/6mm
260 x 20/6mm
300 x 20/6mm



Douglas Fir Nature/Rustic Unfinished*

180x20.5/5.5mm
250x20.5/5.5mm
300x20.5/5.5mm

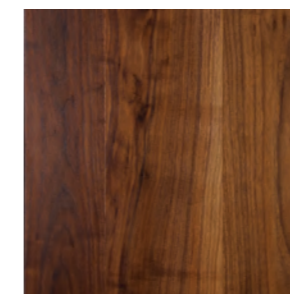

American Black Walnut Prime Unfinished*

180 x 20/6mm



Wenge Prime Unfinished*

180 x 20/6mm

Rustic
140/180/220/260
x 20mm is
IN STOCK with a
**Square Edged
Profile**
all other widths and grades
are produced to order.

STABILITY DESIGN®



BF526

- Produced in Europe
- Profile:** 500 x 90mm T&G all sides - 4 sided micro bevelled (*square edged available to order 4 - 6 weeks*)
600 x 120mm T&G all sides - 4 sided micro bevelled (*square edged available to order 4 - 6 weeks*)
350 x 70mm T&G grooved both ends - square edged (*4 sided micro bevelled available to order 4 - 6 weeks*)
- Thickness:** 10/4mm, 12/3mm, 15/4mm and 20/6mm
- Finish:** Unfinished
- Size:** 280 x 70mm, 350 x 70mm, 500 x 90mm and 600 x 120mm
- Installation:** Glued

* Produced to order - approx 6-8 weeks



European Oak Prime Blocks

500 x 90mm
10/4mm
15/4mm
20/6mm



European Oak Rustic Blocks

500 x 90mm
10/4mm
15/4mm
20/6mm
600 x 120mm
12/3mm



European Oak Prime Blocks

280 x 70mm
15/4mm *
20/5mm *
350 x 70mm
15/4mm
20/5mm



European Oak Rustic Blocks

280 x 70mm
15/4mm *
20/5mm *
350 x 70mm
15/4mm
20/5mm

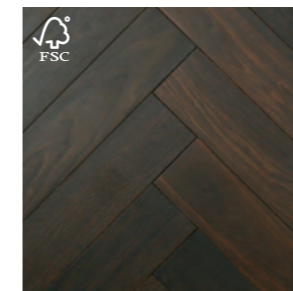

European Oak Prime 'Fumed' Blocks

500 x 90mm
10/4mm *
15/4mm *
20/6mm *

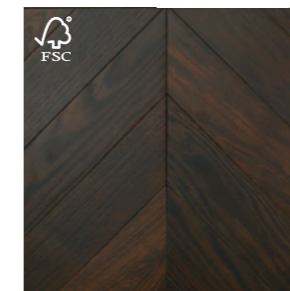

European Oak Prime 'Fumed' Chevrons

500 x 90mm
10/4mm *
15/4mm *
20/6mm *



European Oak Prime Chevrons

500 x 90mm
10/4mm
15/4mm *
20/6mm *



European Oak Rustic Chevrons

500 x 90mm
10/4mm
15/4mm *
20/6mm *

STABILITY DESIGN®



BF1453

FLOORING

- Produced in Europe
- 100% FSC European Oak
- Bespoke finishing available
- Produced to order - 4 - 6 weeks

Profile: Grooved to all sides - supplied with false tongues

Thickness: 15/4mm and 20/6mm

Finish: Unfinished

Installation: Glued

- Images are to show the pattern only and not the grading

Component Sizes

Cube
200mm wide

Mansion Weave
200mm wide centre & 90mm wide weave

Hexagon
200mm wide

Continuous Versaille
350 x 70mm & 140 x 140mm



Cube
Prime 15/4mm
Rustic 15/4mm
Prime 20/6mm
Rustic 20/6mm



Mansion Weave
Prime 15/4mm
Rustic 15/4mm
Prime 20/6mm
Rustic 20/6mm



Hexagon
Prime 15/4mm
Rustic 15/4mm
Prime 20/6mm
Rustic 20/6mm



Continuous Versaille
Prime 15/4mm
Rustic 15/4mm
Prime 20/6mm
Rustic 20/6mm



Cube Fumed
Prime 15/4mm
Rustic 15/4mm
Prime 20/6mm
Rustic 20/6mm

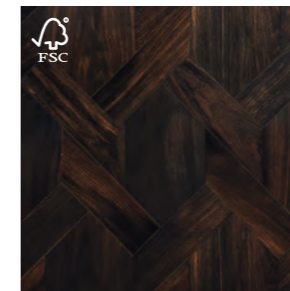

Mansion Weave Fumed
Prime 15/4mm
Rustic 15/4mm
Prime 20/6mm
Rustic 20/6mm



Hexagon Fumed
Prime 15/4mm
Rustic 15/4mm
Prime 20/6mm
Rustic 20/6mm

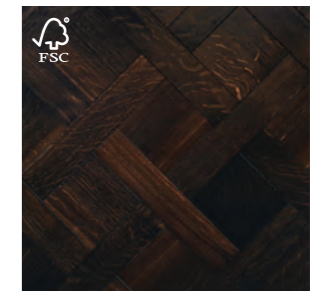

Continuous Versaille Fumed
Prime 15/4mm
Rustic 15/4mm
Prime 20/6mm
Rustic 20/6mm

STABILITY PANELS®



- Produced in Europe
 - Produced to order - 4 – 6 weeks
- Profile:** Grooved to all sides - supplied with false tongues
Thickness: 20/6mm
Finish: Unfinished
Size: 1000 x 1000mm
Installation: Glued



Versailles
Euro Oak Prime

20/6mm



Versailles
Euro Oak Rustic

20/6mm



Chantilly
Euro Oak Prime

20/6mm



Chantilly
Euro Oak Rustic

20/6mm



Versailles
Euro Oak Prime
Tumbled with Dowels

20/6mm



Versailles
Euro Oak Rustic
Tumbled with Dowels

20/6mm



Chantilly
Euro Oak Prime
Tumbled with Dowels

20/6mm



Chantilly
Euro Oak Rustic
Tumbled with Dowels

20/6mm

STABILITY PANELS®



Sanded



Bevelled



Distressed

Surcharge applies per m²:

- Bevelled £8/m²
- Distressed edges £8/m²
- Brushed - light, medium or heavy £8/m²



Design 6

- Produced in Europe
- Produced to order - 4 - 6 weeks

Profile: Grooved to all sides - supplied with false tongues

Thickness: 15/4mm and 20/6mm

Finish: Unfinished

Installation: Glued



Design 1 - 570 x 570mm
15/4mm Prime
15/4mm Rustic
20/6mm Prime
20/6mm Rustic



Design 2 - 660 x 660mm
15/4mm Prime
15/4mm Rustic
20/6mm Prime
20/6mm Rustic



Design 3 - 660 x 660mm
15/4mm Prime
15/4mm Rustic
20/6mm Prime
20/6mm Rustic



Design 4 - 660 x 660mm
15/4mm Prime
15/4mm Rustic
20/6mm Prime
20/6mm Rustic



Design 5 - 800 x 800mm
15/4mm Prime
15/4mm Rustic
20/6mm Prime
20/6mm Rustic



Design 6 - 800 x 800mm
15/4mm Prime
15/4mm Rustic
20/6mm Prime
20/6mm Rustic

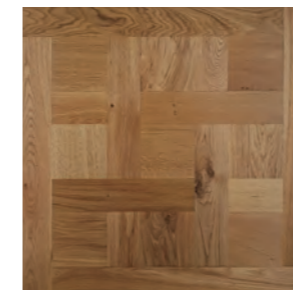

Design 7 - 810 x 810mm
15/4mm Prime
15/4mm Rustic
20/6mm Prime
20/6mm Rustic



Design 8 - 800 x 800mm
15/4mm Prime
15/4mm Rustic
20/6mm Prime
20/6mm Rustic



Design 9 - 840 x 840mm
15/4mm Prime
15/4mm Rustic
20/6mm Prime
20/6mm Rustic



Design 10 - 600 x 600mm
15/4mm Prime
15/4mm Rustic
20/6mm Prime
20/6mm Rustic

TRULY BESPOKE WOOD FLOORS



With the market full of 1000s of combinations of textures, colours and finishes but sometimes restricted to certain widths and grades, we decided to offer a Truly Bespoke service and give you the option to choose what width, grade, texture and finish your client requires.

With an extensive range of unfinished stock of European Prime and Rustic Oak and 100% Fumed Oak we are able to offer you a prompt colour matching service and production time.

PLEASE NOTE The process of sample matching takes **10 working days** as we use the same extensive weighted method of application to ensure precise and consistent application of the oils and stains.

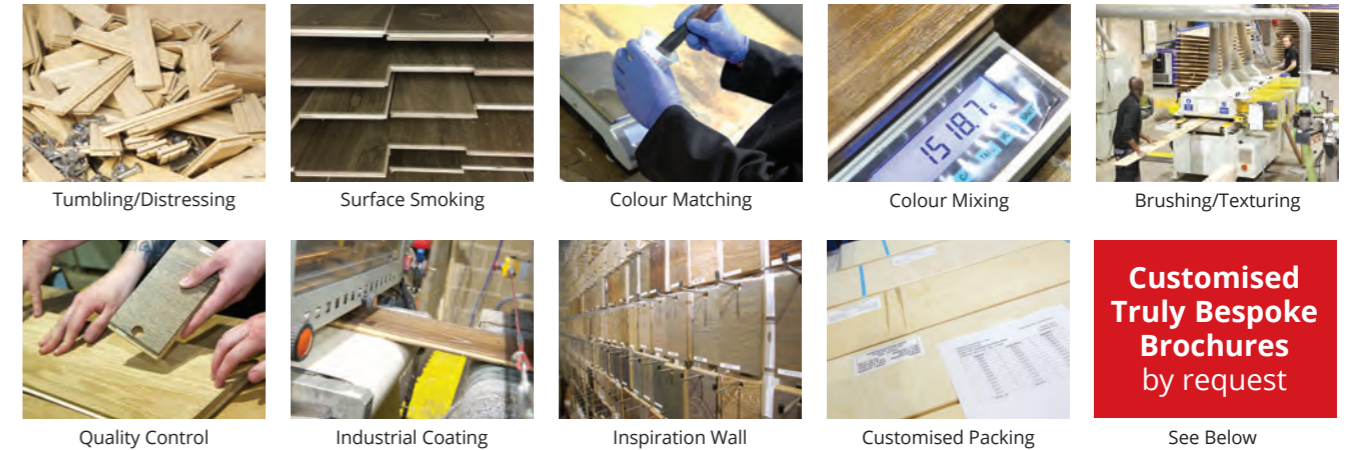

Our Truly Bespoke brochure can be adapted to suit your own company needs and printed digitally for lower quantity requirements.

Simply supply us with your company logo, contact details and finish reference. We will create the brochure, proof for approval and arrange the printing and delivery to you - **Please call for prices.**

Your company name/logos are customised on the cover.
Finish references changed to suit ie; **TBO0901** to **WCO0901**.



These examples are *bespoke colours* created from colour matching to supplied samples.
Call to request yours.

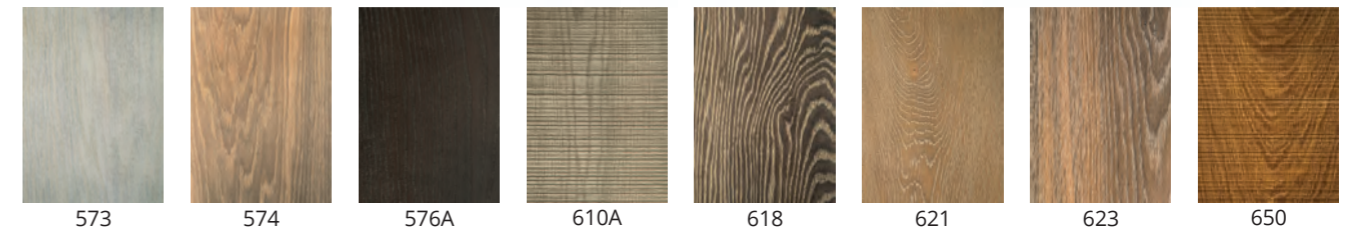
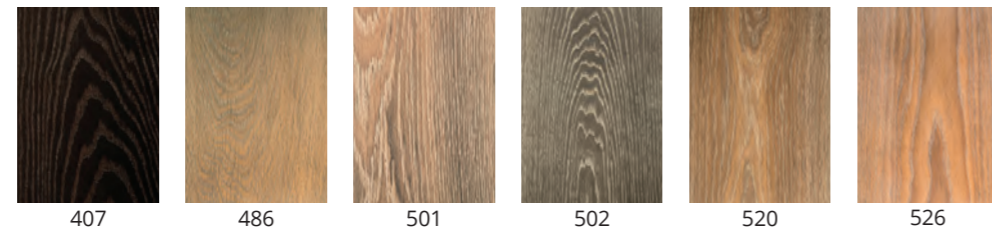

THE LABORATORY



We welcome all architects, designers and installers to visit our Lab. This is where we create our colour magic and are very proud to show off our Truly Bespoke service! Our *inspiration wall* is back and showcases 850 of the 2400+ finishes we've created to date.

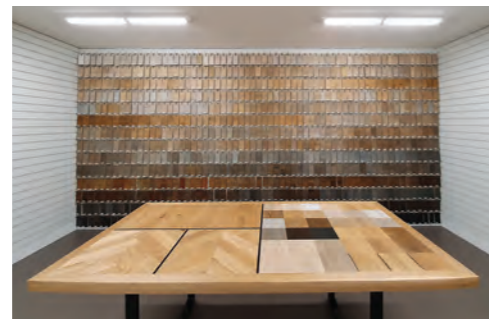

STAIRS AND MOULDINGS

Our Truly Bespoke options are not limited to the production of beautiful floors. Visitors and customers alike are suitably impressed by our products on offer for the *linking of rooms*. This *bespoke service* includes the matching of stairs and mouldings to our ranges; thresholds, beadings and more!

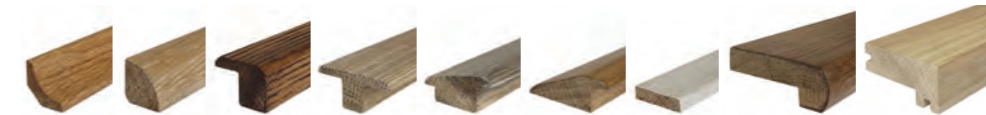

See pages 116 - 117 for mouldings and stair nosings.





GENERAL	Clear grade with mixture of natural grain.
KNOTS	Occasional pin knots < 10mm.
SAPWOOD	Minimal edge and core sapwood.
COLOUR	Natural variation allowed with no heart wood.

GENERAL	Rustic grade with mixture of natural grain and knots.
KNOTS	Healthy sound knots up to 60mm with dead knots up to 25mm and holes firmly filled.
SAPWOOD	Minimal edge and core sapwood.
COLOUR	Natural variation allowed with some heart wood.



Each piece of flooring is tumbled to achieve an authentic aged look to the edges, corners and surface of the timber.

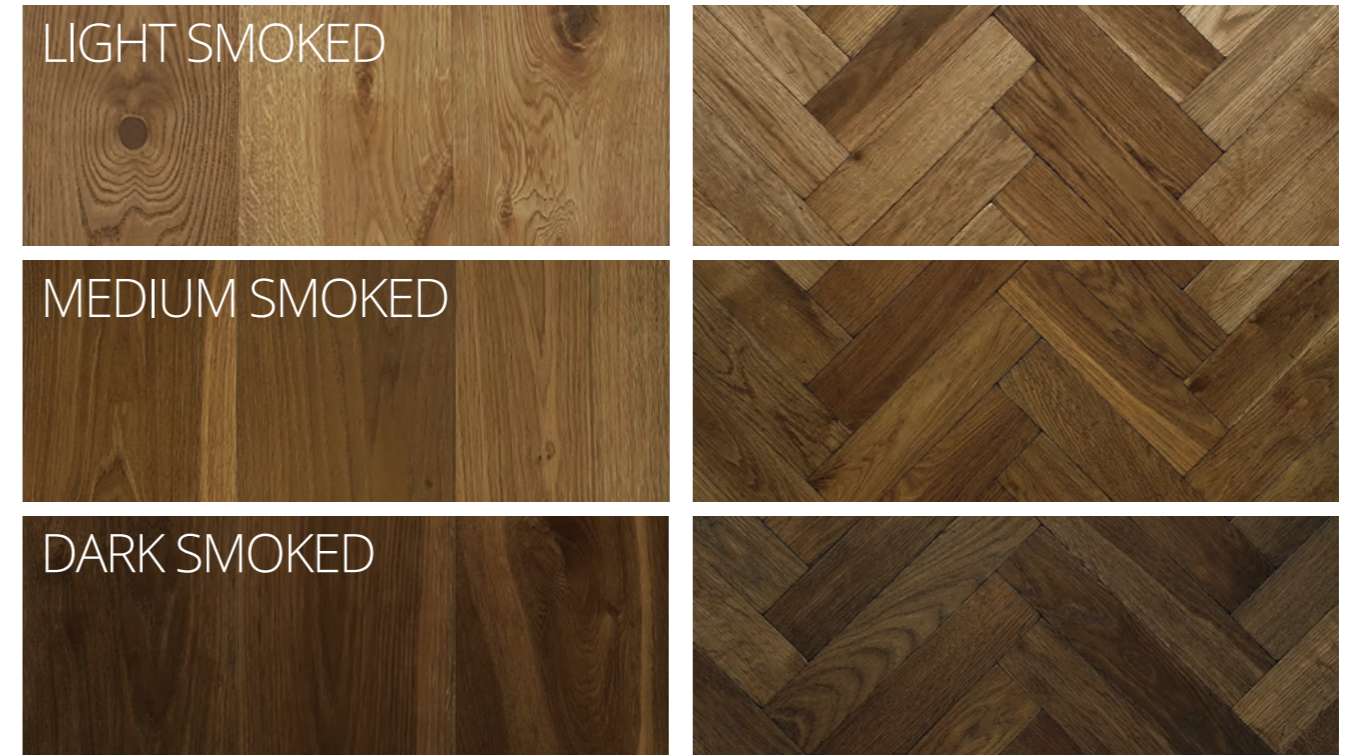

NATURAL	Surface smoked – tones of light to medium brown - <i>variation in colour will occur.</i>
MEDIUM	Surface smoked – tones of medium to dark brown - <i>variation in colour will occur.</i>
DARK	Surface smoked – tones of dark brown - <i>variation in colour will occur.</i>

Our fumed and smoked colours are achieved through a process which reacts with the natural tannins in the oak and although we use controlled processes, the final colours are dictated by nature and not by using pigmented stains.





BF901 Subtle White (Grain Only)



BF902 Standard White



BF903 Intense White

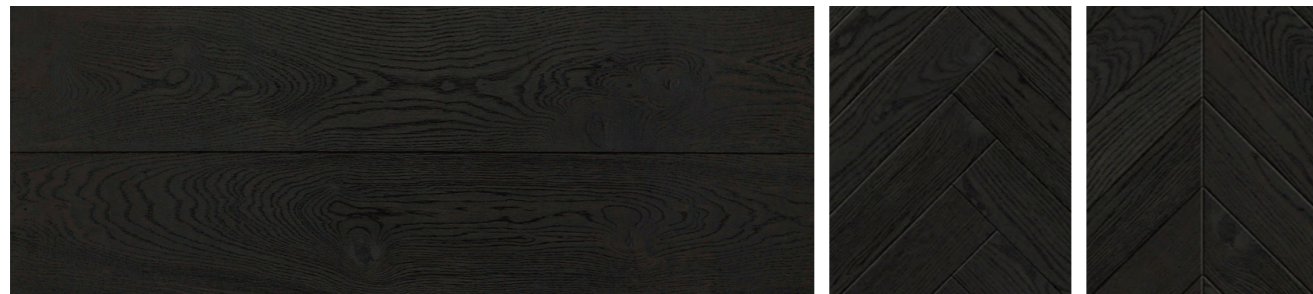

BF904 Intense Black



BF910 Matt UVM



BF911 Satin UVS



BF916 Antique Brown

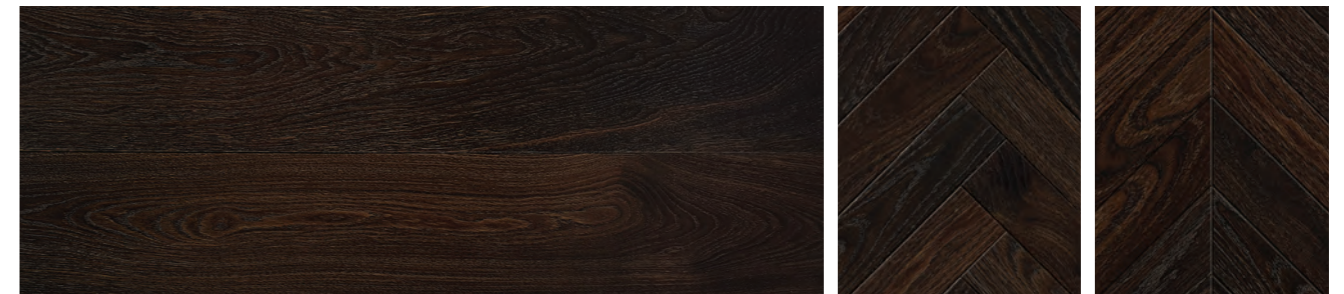

BF920 Satin (on 100% Fumed)



BF921 Light Smoked



BF923 Light Smoked White (Grain Only)



BF922 Light Smoked White



BF929 Dark Smoked White

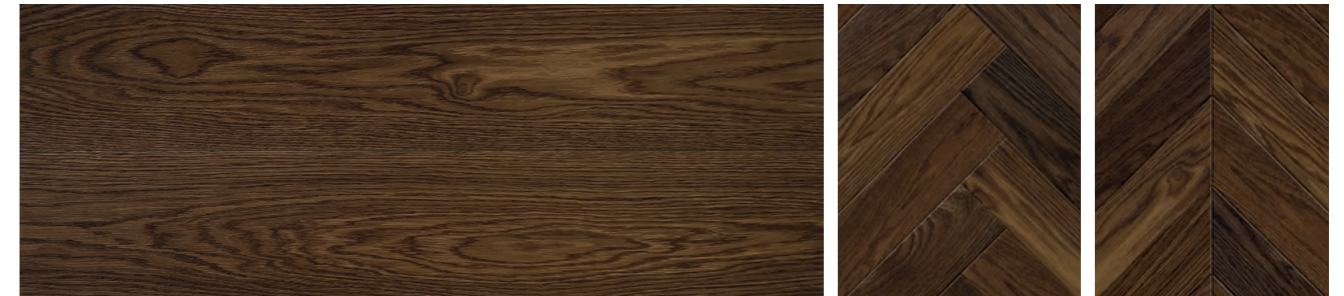

BF941 Dark Smoked



BF521 Medium Smoked Natural (Grain Only)



BF497 Heavy Brushed Dark Smoked White Matt



BF569 Heavy Brushed Grey



BF938 Light Grey



BF939 Dark Grey



BF526



BF512 Woodlook Matt



BF1975 Medium Smoked & Bespoke Oil



BF1976 Medium Smoked & Bespoke Oil



BF610



BF1586 Torched & Light Smoked



BF1587 Torched, Tumbled & Light Smoked



BF1588 Torched, Bandsawn & Light Smoked



Our torched process is only available in our range of plank floors on the long edges, not the short ends, from + £8.00 m².

Call for samples.



BF512



BF912 Tumbled



BF924 Tumbled Light Smoked



BF943 Tumbled Dark Smoked



BF925

Our tumbled texture is available for all the Truly Bespoke wood floor finishes from + £6.00 m² **see page 30** for details on tumbling.

Call for samples.



BF919 Tumbled White



BF925 Tumbled Light Smoked White



BF932 Tumbled Dark Smoked White



BF943



BF913 Bandsawn



BF926 Bandsawn Light Smoked

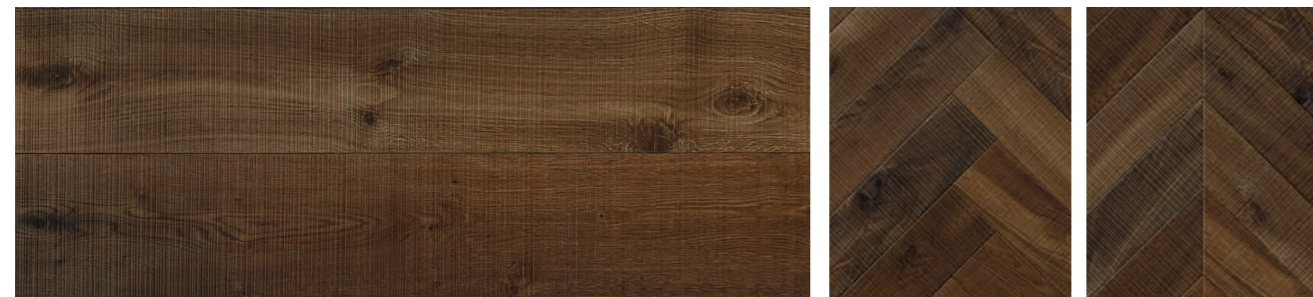

BF944 Bandsawn Dark Smoked



BF419



BF914 Bandsawn White



BF419 Bandsawn Light Smoked Sand



BF934 Bandsawn Dark Smoked White



BF934

Our bandsawn texture is available with all our Truly Bespoke wood floor finishes + £10.00 m² see **page 31** for details on our smoking process.

Call for samples.

BESPOKE FLOORING

- Bespoke manufacturing service
- 6/9mm square edged parquet flooring
- 15/20mm T&G flooring
- Any design, any size, any wood species
- Laser cut motifs and borders
- Tumbling/distressing, smoking and prefinishing available for some products
- Approx 4 weeks delivery subject to specification
- **ALL bespoke orders are non-returnable**

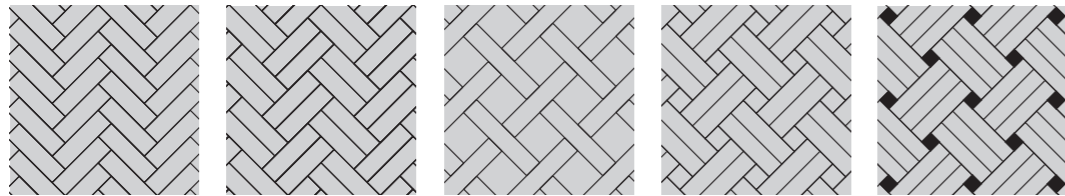

Herringbone Double Herringbone Single Basket Weave Double Basket Weave Treble Basket Weave

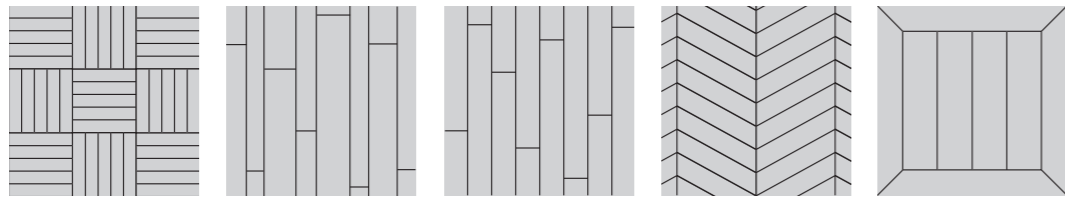

Basket 5:1 Random Width Strip Set Width Strip Chevron Mitre Bordered Basket Panel 4:1

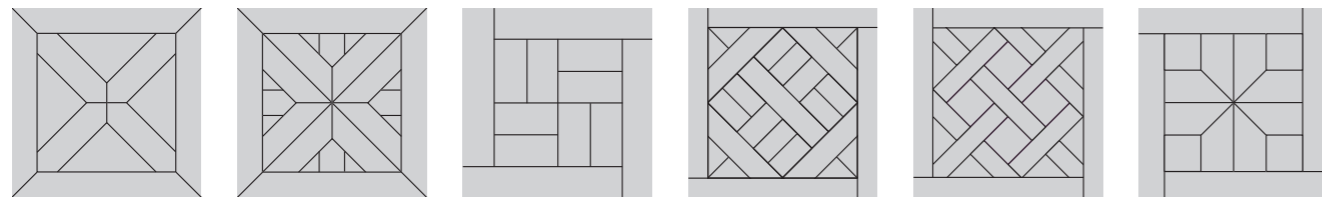

Single Breton Cross Double Breton Cross 4-Carreux Square Versailles Panel 1 Versailles Panel 2 Mill-Wise Bordered Double Cross



Quarter sawn Oak (100% Quarter sawn) Exquisite Oak (Quarter sawn / flatsawn) Natural Oak (Small to medium size knots) Rustic Oak (Medium to large open knots)



Aframosia Afzelia Doussie American Red Oak Ash Basralocus Merbau

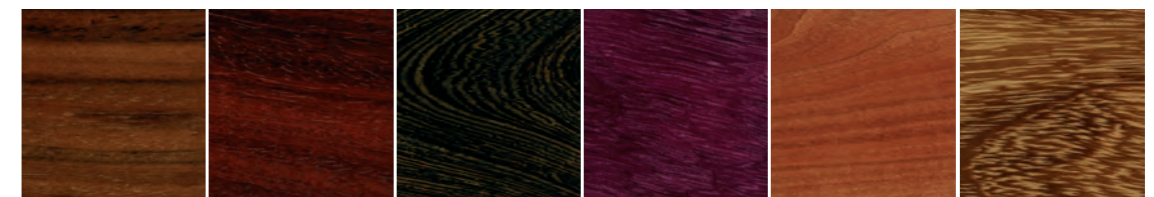

Mutenye Padoek Panga Panga Purple Heart Cherry Iroko

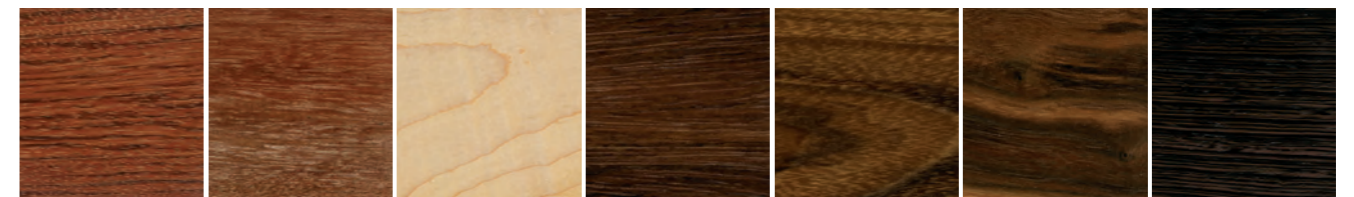

Jatoba Keruing Maple Sucupira Teak Walnut Wenge

FLOORING

KÄHR'S



Oak Como 3 Strip

- 3 strip lacquered
 - Engineered flooring
 - 30 Year Warranty
- Board Size:** 15 x 200 x 2423mm
Pack Size: 2.91m²
Finish: Prefinished
Wear Layer: 3.50mm
Installation: Floating



5s LOC



Oak Como
3 Strip - Lacquered
200 x 15mm

Don't forget...

Sales
 Call 020 8501 6730
 Delivering 6 days a week

*Subject to delivery terms



MACHINERY & ACCESSORIES ORDERS PLACED BEFORE 3PM

Standard Next Day **FREE** on orders over £150.00 +VAT
 Standard Next Day **£10.00** on orders below £150.00 +VAT

EXPRESS DELIVERY COSTS

Next Day Before 10.30am **£30.00** +VAT
 Next Day Before 12.00pm **£25.00** +VAT
 Saturday Before 10.00am **£40.00** +VAT

NOTE: THE ABOVE PRICES **EXCLUDE** DELIVERIES FOR RECLAIMED FLOORBOARDS AND VARIOUS PRODUCTS WITHIN THE ACCESSORIES SECTION AND WILL BE QUOTED PER ORDER.

ELEGANCE



Stone

- Engineered flooring
 - 2 sided micro bevelled edges
- Thickness:** 14/3mm
Length Specification: 1900mm
Finish: Prefinished
Installation: Floating/glued/secret nailed

2 NEW COLOURS



Oak Select AB
NEW Mystical Grey
 Lacquered
 189 x 14/3mm



Oak Select AB
NEW Marble
 Lacquered
 189 x 14/3mm



Oak Select AB
 Filled and Sanded
 Unfinished
 189 x 14/3mm



Oak Select AB
 Invisible
 189 x 14/3mm



Oak Rustic
 Invisible
 189 x 14/3mm



Oak Select AB
 UV Oiled
 189 x 14/3mm

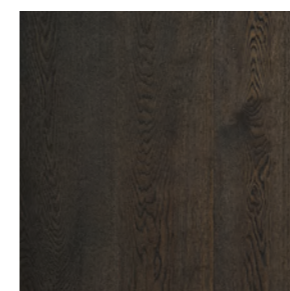

Oak Rustic
 Earth
 Matt Lacquered
 189 x 14/3mm



Oak Rustic
 Stone
 Matt Lacquered
 189 x 14/3mm



Oak Rustic
 Granite
 Matt Lacquered
 189 x 14/3mm



Oak Rustic
 Slate
 Matt Lacquered
 189 x 14/3mm

END GRAIN



Oak End Grain Rustic 3:1

- End grain is also available tumbled as shown on the right - prices on request
FSC/PEFC: Available on request
Delivery Time: On request
Delivery Cost: On request, subject to quantity
Finish: Unfinished
Installation: Fully glued



- Please note that sizes may change due to the availability of raw materials



Oak End Grain Nature
(3:1 Squares)
60 x 20 x 18mm



Oak End Grain Rustic
(3:1 Squares)
60 x 20 x 18mm

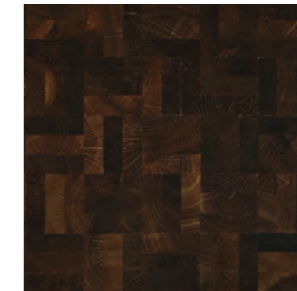

Oak End Grain Nature Fumed
(3:1 Squares)
60 x 20 x 18mm



Oak
85 x 40 x 18mm

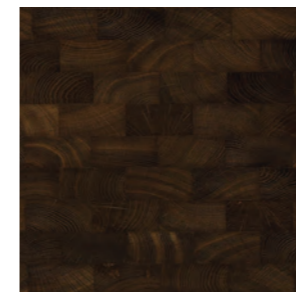

Oak Fumed
85 x 40 x 18mm



Pine
88 x 68 x 18mm



Spruce
88 x 58 x 18mm



Larch
88 x 68 x 18mm

MOSAIC PANELS



Oak

Profile: Square edged
Thickness: 8mm
Size: 120 x 24mm per finger - 480 x 480mm panel
Finish: Unfinished
Installation: Glued
Pack Size: 10 panels per pack = 2.304m²
 this is at the time of going to press and subject to change



FLOORING



European Oak Mesh Backed Panels
 Unfinished
 480 x 480 x 8mm



Mahogany Mesh Backed Panels
 Unfinished
 480 x 480 x 8mm

Don't forget...

Sales

Call 020 8501 6730

Delivering 6 days a week



*Subject to delivery terms

MACHINERY & ACCESSORIES ORDERS
 PLACED BEFORE 3PM

Standard Next Day	FREE	on orders over £150.00 +VAT
Standard Next Day	£10.00	on orders below £150.00 +VAT

EXPRESS DELIVERY COSTS

Next Day Before 10.30am	£30.00	+VAT
Next Day Before 12.00pm	£25.00	+VAT
Saturday Before 10.00am	£40.00	+VAT

NOTE: THE ABOVE PRICES EXCLUDE DELIVERIES FOR RECLAIMED FLOORBOARDS AND VARIOUS PRODUCTS WITHIN THE ACCESSORIES SECTION AND WILL BE QUOTED PER ORDER.

PARQUET BATTENS



Oak Prime

Profile: Square edged
Thickness: 9/10mm
Finish: Unfinished
Installation: Glued and pinned to plywood

* French Oak produced to order 2 - 4 weeks



FLOORING



European Oak Prime Parquet Battens

280 x 70 x 10mm
 350 x 70 x 10mm



European Oak Rustic Parquet Battens

280 x 70 x 10mm
 350 x 70 x 10mm

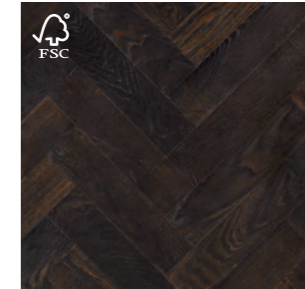

European Oak Prime Fumed Parquet Battens

350 x 70 x 10mm

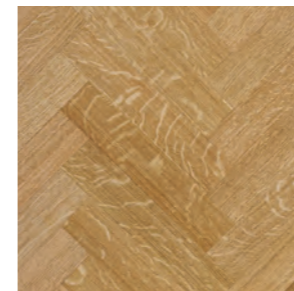

French Oak Quarter Sawn Parquet Battens Unfinished

350 x 70 x 9mm



French Oak Exquisite Parquet Battens Unfinished

350 x 70 x 9mm

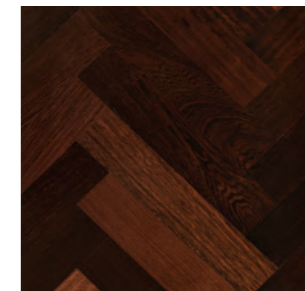

Wenge Parquet Battens

350 x 70 x 10mm

PARQUET STRIP



Oak Rustic

Profile: Square edged
Thickness: 9/10mm
Finish: Unfinished
Installation: Glued and pinned to plywood
Length: 9mm approx 1000 – 2500mm (average 1800mm)
Specs: 100 x 10mm approx 600 – 2500mm (average 1400mm)
 150/180 x 10mm approx 1400 – 2500mm (average 1800mm)



* French Oak produced to order 2 – 4 weeks



European Oak Prime Parquet Strip

100 x 10mm
 150 x 10mm
 180 x 10mm



European Oak Rustic Parquet Strip

100 x 10mm
 150 x 10mm
 180 x 10mm



European Oak Prime Fumed Parquet Strip

180 x 10mm



French Oak Quarter Sawn Parquet Strip

100 x 9mm
 140 x 9mm
 180 x 9mm



French Oak Exquisite Parquet Strip

100 x 9mm
 140 x 9mm
 180 x 9mm



French Oak Rustic Monastery Parquet Strip

210 x 9mm

PARQUET PANELS



Oak Exquisite Versailles

- Produced to order
- Profile:** Square edged
- Thickness:** 9mm
- Finish:** Unfinished
- Installation:** Glued and pinned to plywood



FLOORING



Oak Exquisite Versailles Parquet Panel 1



Oak Exquisite Versailles Parquet Panel 2



Oak Exquisite Mitred Bordered Basket 4:1 Parquet Panel



Oak Exquisite 4 Carreaux Square Parquet Panel



Oak Exquisite Single Breton Cross Parquet Panel



Oak Exquisite Double Breton Cross Parquet Panel



Oak Exquisite Mill Wise Bordered Double Cross Parquet Panel



Also available in the ABOVE wood species in various sizes to order

PARQUET BORDERS

- All Inset Strips and 10mm 2 Line Borders are **IN STOCK**
- All design Borders are produced to order

Profile: Square edged

Thickness: 10/22mm

Length Specification: Random lengths Approx 1200mm – 1500mm

Delivery Time: Approx 4 weeks for design borders

ANY
DESIGN
AVAILABLE
TO ORDER



Greek Key - Oak & Amazakoue



Greek Key - 140mm
Oak & Sapele
Key Square



Greek Key - 140mm
Oak & Amazakoue
Key Square



Greek Key - 140mm
Amazakoue & Oak
Key Square



Simplicity - 140mm
Amazakoue & Oak
Key Square



Grill - 110mm
Amazakoue & Oak
Key Square



Weavered Lines - 175mm
Amazakoue, Oak
& Sycamore
Key Square



Victorian - 175mm
Amazakoue, Oak
& Sycamore
Key Square



Fantasia - 173mm
Oak, Sapele, Sycamore
& Wenge
Key Square

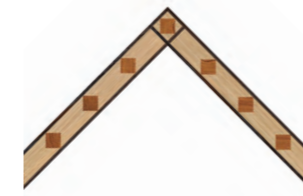

Infinity - 63mm
Oak, Wenge & Jatoba
Key Square



Carnevale - 90mm
Oak, Wenge & Jatoba
Key Square - **N/A**



Chain - 110mm
Amazakoue & Oak
Key Square



Palazzo - 130mm
Oak, Wenge & Jatoba
Key Square - **N/A**

PARQUET MOTIFS

- Produced to order
- Supplied in sections marked for installation/assembly
- Call for prices

Profile: Square edged

Thickness: 10mm

Delivery Time: Approx 2 – 3 weeks

Each of the patterns can be created in other wood species combinations and with sizes modified to accommodate individual projects, please call for details.



Paganio - 762mm
Oak, Sapele, Sycamore & Wenge



Paganio 762mm - Oak, Sapele, Sycamore & Wenge



8 Ray MQF I
762mm
Oak, Amazakoue & Sycamore



8 Ray Simple
762mm
Oak, Amazakoue & Sycamore



8 Ray DF I
1500mm
Oak, Amazakoue & Sycamore



8 Ray MQF II
762mm
Oak, Sycamore & Wenge



Oriental
800mm
Wenge & Sapele



8 Ray MQF Square
762mm
Oak, Amazakoue, Sapele & Sycamore



Compass I
762mm
Sapele, Oak & Wenge



Compass II
900mm
Oak, Amazakoue & Sycamore



Black and White
762mm
Oak, Wenge & Sycamore



Leaves & Acorns
762mm
Oak, Wenge & Sycamore



Neptune
900mm
Oak, Amazakoue & Sycamore



Northern Star
762mm
Oak, Amazakoue & Sycamore

SOLID T&G WOOD STRIP UNFINISHED



Canadian Maple

Profile: T&G, ends matched and square edged
Thickness: 20mm
Finish: Unfinished
Installation: Secret nailed/glued
Length Specification: Random lengths approx 300 – 2100mm



* Available to order - Bevelled or square edged with 2 – 3 day delivery, POA for transport costs.

FLOORING

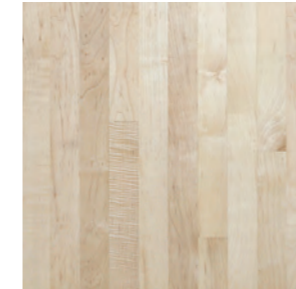

Canadian Maple
Select & Better

57 x 20mm

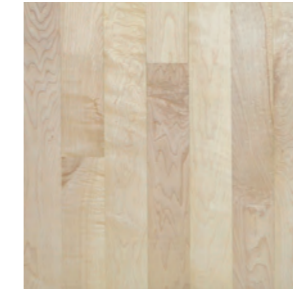

Canadian Maple
Select & Better

83 x 20mm

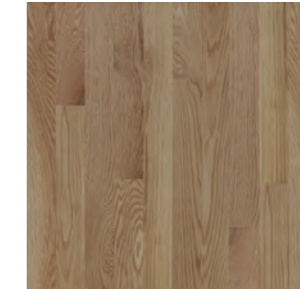

American White Oak
Select & Better

57 x 20mm



American White Oak
Select & Better

83 x 20mm



European Oak - Rustic*

120 x 20mm
 140 x 20mm
 160 x 20mm
 180 x 20mm
 200 x 20mm

SOLID T&G WOOD BLOCKS UNFINISHED



European Rustic Oak

Profile: T&G all round
Thickness: 15/20/22mm
Finish: Unfinished
Installation: Glued



22mm x 12mm
Mahogany Inset Strip



22mm x 12mm
Walnut Inset Strip

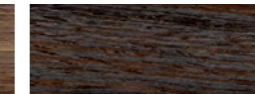

22mm x 12mm
Wenge Inset Strip



FLOORING



European Prime Oak

230 x 70 x 22mm
280 x 70 x 22mm
350 x 70 x 22mm



European Rustic Oak

230 x 70 x 22mm
280 x 70 x 22mm
350 x 70 x 22mm

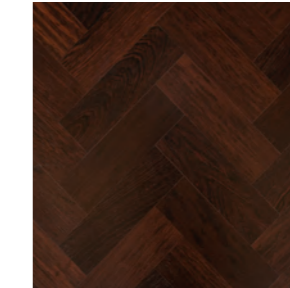

Wenge Prime

230 x 70 x 20mm

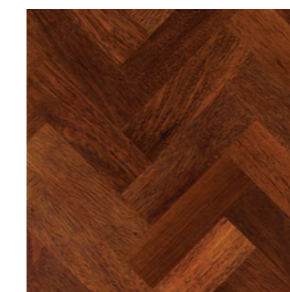

Merbau Prime

230 x 70 x 15mm
230 x 70 x 20mm

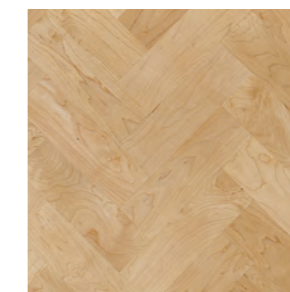

Maple Prime

230 x 70 x 20mm



Teak

230 x 70 x 20mm

TUMBLED BLOCKS AND BATTENS

Our tumbled blocks and parquet battens provide an authentic aged appearance to suit residential and commercial projects. With subtle surface damage and slightly rounded corners, each piece has its own character to provide a great alternative to reclaimed blocks.

- Our solid T&G blocks and battens are tumbled to order

Profile: T&G, square edged

Thickness: 10/15/20/22mm

Finish: Unfinished

Installation: Glued/glued and pinned to plywood



European Rustic Oak, Tumbled and Medium Smoked



European Prime Oak
Tumbled Solid Blocks
230 x 70 x 22mm
280 x 70 x 22mm
350 x 70 x 22mm



European Rustic Oak
Tumbled Solid Blocks
230 x 70 x 22mm
280 x 70 x 22mm
350 x 70 x 22mm



European Prime Oak
Tumbled Parquet Battens
280 x 70 x 10mm
350 x 70 x 10mm



European Rustic Oak
Tumbled Parquet Battens
280 x 70 x 10mm
350 x 70 x 10mm

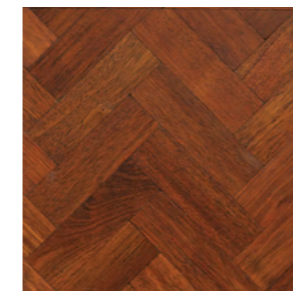

Merbau Prime
Tumbled Solid Blocks
230 x 70 x 15mm
230 x 70 x 20mm



European Oak Prime
Engineered Blocks
350 x 70mm
15/4mm
20/5mm



European Oak Rustic
Engineered Blocks
350 x 70mm
15/4mm
20/5mm



Light Smoked



Medium Smoked



Dark Smoked





RECLAIMED FLOORBOARDS

- Widths subject to available stock

Profile: Square edged

Thickness: 20mm

Finish: Unfinished

Length Specification: Random lengths approx 1200 – 2500mm



Reclaimed Pine Floorboards

175 x 20mm

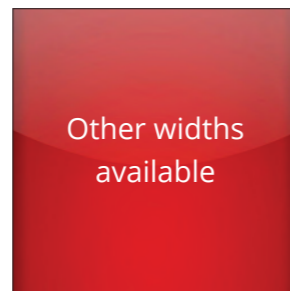

Other widths available

Don't forget...

Sales

Call 020 8501 6730

Delivering 6 days a week

*Subject to delivery terms



Stopgap
Solution for draughty
floorboards
Reduces draughts and
provides a base for filler
Fast & easy to fit

40m Roll
Available in Clear or Brown



Headless Pins, Staples,
Brads & Concrete Nails
see pages 114 - 115



Ace & K Multi T-Nailer

Nail length 18-64mm

Use to fix plywood to concrete.



Ace & K 90 Type Stapler

Nail length 12-25mm

Use to fix plywood to timber.



Ace & K 16g Brad Nailer

Nail length 19-64mm

Use to fix timber to timber.



Ace & K 16g Angled Nailer

Nail length 25-50mm

Use to fix architraves, paneling, skirtings and beading.



Omer 90 Type Stapler

Nail length 9-32mm

Use to fix plywood to timber.



Omer PR18 23g Headless Pin Gun

Pin length 10-18mm

Use to fix 6/10mm parquet/ scotia beading and delicate mouldings in place whilst the adhesive cures.



Omer PR28 23g Headless Pin Gun

Pin length 15-28mm

Use to fix 6/10/14mm parquet/scotia beading and delicate mouldings in place whilst the adhesive cures.



Bona FlexiSand 1.9
KEY BENEFITS

- 25% greater motor power and heavier weight compared to FlexiSand 1.5
- Easy and ergonomic operation
- Dust containment ready
- Foldable handle
- Big wheels for easy transportation
- Prepared for the Bona Power Drive
- Effective concrete grinding with Bona Concrete Disc

With its powerful 1.9 kW motor and robust construction it runs smooth and cool even under a heavy load. Bona FlexiSand 1.9 is prepared for the Bona Power Drive, a unique drive plate that allows powerful rotary sanding to bare wood.

See Page 76 for attachments.



Bona FlexiSand 1.5
KEY BENEFITS

- Powerful single-speed motor
- Foldable handle reduces space during transportation
- Large wheels for easy transportation
- Bona Power Drive ready

With its powerful 1.5 kW motor and robust construction ensures stable operation even when under heavy load. Bona FlexiSand 1.5 is compatible with the Bona Power Drive, a unique drive plate that allows powerful, direction free sanding down to bare wood. For optimal dust reduction, the Bona FlexiSand 1.5 is compatible with Bona DCS 70.



Bona Edge
KEY BENEFITS

- High cut rate
- Good reachability
- Effective pickup

It is equipped with a lamp for better visibility and its shorter sanding arm improves manoeuvrability and reduces strain on arms and hands. For optimal dust reduction, the Bona Edge is compatible with Bona DCS 70.



Bona Edge XL
KEY BENEFITS

- High cut rate
- Easy to handle
- Effective dust pickup
- For both holed discs and Velcro discs
- Easy to carry

Bona Edge XL (220 mm) is an extremely powerful edge sander. It can be fitted with 'holed discs' or Velcro-backed discs and picks up dust better than most edge sanders on the market. It is equipped with a lamp for better visibility and is easy to operate. For optimal dust reduction, the Bona Edge XL is compatible with Bona DCS 70.



Bona Belt Sander
KEY BENEFITS

- Powerful wood floor sander
- Ergonomic design with convenient lifting and lowering of the sanding drum
- Easy-start motor
- High weight for powerful sanding
- Infinite pressure adjustment: up to 50% of its weight can be adjusted to the sanding drum
- Easy fitting and changing of paper, no tools needed

All adjustments can be made from the top of the machine and the sanding drum is easily exchanged to another width if needed. The unique drum construction makes changing the abrasive belt a job done in seconds. Bona Belt has a highly efficient vacuum unit that minimizes dust. For optimal dust reduction, connect it to Bona DCS 70.



Bona Belt Lite Sander
KEY BENEFITS

- Optimal balance between weight and drum pressure
- Superior manoeuvrability
- Easy fitting and changing of paper
- Low weight of 60 kg
- Infinite pressure adjustment: up to 50% of its weight can be adjusted to the sanding drum
- Can fit distressing drums to texture wood floors on site

All adjustments can be made from the top of the machine and the sanding drum is easily exchanged to another width if needed. The unique drum construction makes changing the abrasive belt a job done in seconds. Bona Belt has a highly efficient vacuum unit that minimizes dust. For optimal dust reduction, connect it to Bona DCS 70.



Bona CombiEdge
KEY BENEFITS

- Arm easily replaced for sanding under stairs
- Lightweight construction
- Integrated LED
- Very manoeuvrable
- High sanding and working speed
- Lightweight
- Efficient vacuuming
- Safety operating switch button on the handle

It is equipped with a lamp for better visibility and its shorter sanding arm improves manoeuvrability and reduces strain on arms and hands. For optimal dust reduction, the Bona Edge is compatible with Bona DCS 70.



Bona Belt HD Sander
KEY BENEFITS

- High weight for powerful sanding
- Dual speed for optimum sanding results
- Easy fitting and changing of paper
- Can fit distressing drums to texture wood floors on site
- Infinite pressure adjustment: up to 50% of its weight can be adjusted to the sanding drum

The unique dual-speed pulley system and infinite drum pressure adjustment guarantee optimum sanding quality regardless of wood species. It can be easily disassembled into three parts and quickly reassembled. Power, reliability and capability as an effective all-around belt sander. For optimal dust reduction, the Bona Belt HD is compatible with Bona DCS 70.



Bona FlexiSand 1.9
KEY BENEFITS

- Powerful, single phase motor
- Forced driven geared drive plate
- Four individually geared grinding pads
- Easy and ergonomic operation
- Large wheels for easy transportation
- DCS compatible for dust-free sanding
- Multiple drive plate capability



Bona SupraFlex & Accessories
All in one sanding machine for sanding of edges as well as for wire brushing of edges.

KEY BENEFITS

- Powerful 1400 W motor
- Stepless speed selection (600-2100 rpm)
- Dust cover allows connection to Bona DCS for dust free sanding
- M14 tool fixture – easy to change between sanding disc to brushes
- Noise reduction



Bona Power Drive
Used exclusively with the Bona FlexiSand 1.5 & 1.9 for sanding down to bare wood.



Bona Power Drive NEB
Used exclusively with the Bona FlexiSand machines.



Bona FlexiSand 4 Head Quattro Disc
Perfect for reducing/smoothing out drum marks and rotational scratches from edger machines.



Bona FlexiSand Concrete Disc
Basic drive plate for fitting different types of sanding segments with magnetic fixing for quick and easy change overs.



Bona FlexiSand 6 Head Multidisc
With its six-plate construction, the Bona Multidisc creates an exceptionally smooth and flat surface finish.



Bona Concrete Diamond Segment
For removing the sinter layer from levelling compounds and or screeds - *other segments available.*



Silverstone II Compressor

- Lightweight - 11KG
- 5Ltr Tank, 8 Bar Pressure, 115 PSI, 0.50 HP Motor
- Very good noise level
- Oil free & maintenance free
- Compact size – 400mm L x 150mm W x 400mm H
- Suitable for headless pin guns, staplers, brad guns & other pneumatic equipment



Extreme 3T Compressor

- Lightweight - 19KG
- 5Ltr Tank, 10 Bar Pressure, 145 PSI, 1.50 HP Motor
- Very good noise level
- Oil free & maintenance free
- Compact size – 550mm L x 340mm W x 380mm H
- Suitable for headless pin guns, staplers, brad guns & other pneumatic equipment

Delivery.. **ORDERS FOR STOCK ITEMS PLACED BEFORE 3PM ON MACHINERY & ACCESSORIES**

Standard Next Day - Business Hours **FREE** on orders over £150 +vat
Standard Next Day - Business Hours **£10.00** +vat on orders below £150 +vat

Sales
Call 020 8501 6730
Delivering 6 days a week

EXPRESS DELIVERY COSTS
Next Day - Before 10.30am **£30.00** +vat Before 12.00pm **£25.00** +vat
Saturday - Before 10.00am **£40.00** +vat

NOTE: The above prices **exclude** deliveries for RECLAIMED FLOORBOARDS, BATTENS - dependent on quantity, UNDERLAYS, PRO CARD, PLYWOOD, HARDBOARD AND SOME ADHESIVES. These products will be quoted per order due to either their size, weight or flammability properties.



Compressor Air Gun



25ft Hose & Quick Release Fitting



Y Piece Connector
Connect 2 Hoses, universal and PCL.

Spare Parts Available



Re-finishing for floors starts with using the Diamabrush™ by Malish.

Diamabrush Clutch
Universal 5" plates for use with buffing machines. As shown left Numatic, middle Tru-Fit and right Whirble.

Replacement Blade Kit
For mastic removal tool.

Replacement Blade Kit
For hardwood prep tool.

16" Diamabrush Mastic Removal Tool 25g
Designed to remove stubborn coatings from concrete such as mastic, carpet or tile adhesive, thin-set and thin coatings like urethane or paint. Easy to use without heavy grinding equipment or harmful chemicals, mounts to any standard floor buffer or auto scrubber and uses diamond coated blades to grind tough coatings away!

15" Diamabrush Hardwood Prep Tool 50g
KEY BENEFITS

- Blades feature 2 cutting edges
- Available in sizes from 305mm - 508mm
- Designed to fit a wide variety of rotary floor machines
- Removes polyurethane, varnishes and even hard to remove coatings such as carpet or tile glue residue

Blades feature 2 cutting edges. When diamonds wear on one side, simply turn the blades and use cutting edge on other side. Ideal for the toughest removal jobs on hardwood floors. Will not gouge wood or leave heavy scratches on floor surfaces. Low-profile design enables the tool to travel seamlessly over heat registers carved out in the floor.

Fidbox
The black box data recorder for the flooring industry.

Available To Download



THE Electronic Monitoring System for the flooring industry helping protect floors and reputations against:



CUPPING WARPING OPEN JOINTS BUCKLING

WOOD FLOORS + UNDERFLOOR HEATING = USE FIDBOX

Hmbox & Replacement Adhesive
Measure slab moisture.

- Simple remote measurement of screed and room conditions
- Cost savings – reduce wasted time and expense of site visits
- Predict the right time for installation of floor coverings
- Data available anywhere from browser or APP for multiple users



Know site conditions without having to visit site
Through the web-based solution the measurement results can be retrieved at any time. Corrective action can be quickly taken to create an optimum climate on the construction site for the installation of floor covering.

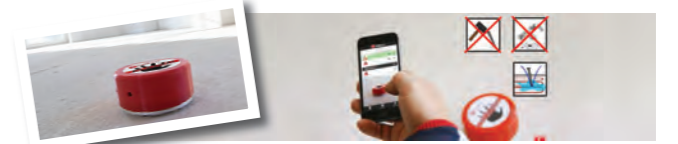

SCREEDS + DIGITAL MEASURING = USE HMBOX



Fein MultiMaster 350 QSL Quickstart Starlock Kit
110/230V
New model with improved motor and quick release connector.



Fein Dustex 25 L Wet / Dry Dust Extractor
110/240V
Compact, powerful wet / dry dust extractor for connecting to power tools when working on site.



Fein Dustex Replacement Dust Bags 25 L
5 x fleece filter bags for use with Fein Dustex 25 L above. Tear-resistant bags work with the cartridge filter to ensure the collection of debris, for wet or dry use and non-reusable.

Universal fitting - For Fein, MultiMaster, Bosch, Makita, DeWalt & Milwaukee Multi Tools



Fein MultiMaster Starlock Sanding Pad 'SL'
Plastic carrier plate for preventing damage and marks on the workpiece. Triangular shape, hook and loop fastening. Perforated version for sanding with dust extraction.



Fein Sanding Sheets
40g/60g/80g/100g
Also available in the perforated version, please ask.



Fein Starlock Blades
35mm & 65mm for the MultiMaster. Tool changes possible in just 3 seconds!



Fein MultiMaster Depth Stop
Depth stop for all saw blades. For accurate working at depth. Effective protection for blade and workpiece.



Surebuild Delta Sanding Pad
80mm



Surebuild Bi-Metal Flush Cut Precision Hardwood Wood Blade
32mm



Surebuild CRV - Wood Blade
68mm



Surebuild CRV - Wood Blade
34mm



Surebuild CRV - Wood Blade
87mm



Surebuild Bi-Metal Plunge Cut Wood & Metal Blade
65mm

MACHINERY & TOOLS

Festool TS55 REBQ - Plus - GB - FS Circular Saw
110/240V



Includes

- FS1400mm guide rail
- splinterguard
- universal saw blade
- hex key, WAF 5

Cuts up to 55mm. Use to cut Perimeter Borders.

Festool TS75 EQ - Plus - GB - FS Circular Saw
110/240V



Includes

- FS1400mm guide rail
- splinterguard
- universal saw blade
- hex key, WAF 5

Cuts up to 75mm. Use to cut Perimeter Borders.

TSC55 Li 5,2 REB - Set/XL - FS Cordless Plunge Saw
110/240V



Includes

- Guide rail & splinterguard
- 2 airstream battery packs
- 2 rapid chargers
- fine tooth saw blade
- hex key, WAF 5

Cuts up to 55mm. Use to cut Perimeter Borders.

Festool Guide Rails



Available in 3 different lengths 800, 1400 and 2400mm, please call for other sizes available.

Festool Guide Rail Connector



Joins two tracks together.

Festool Guide Rail Splinter Guard



Transparent replacement splinter guard for guide rails FS1400 and FS5000.

Festool Guide Rail Adhesive Cushion Strip



10m roll, replacement adhesive cushion strip for FS and FS/2 guide rail.

Festool Fine Saw Blades TS55 48 Tooth & TS75 52 Tooth



Cutting width 2.20mm. For clean and splinter-free cross cuts in solid wood.

Festool Fastening Clamp FSZ 120



Clamping width 120mm for securing the guide rail in place. Two in the pack.

Festool Padded Guide Rail Bag



Festool Guide Rail Deflector



Prevents suction hoses and cables from catching on the end of the guide rail.

Festool Slideway Lining
10m



Festool T18+3 Li 5.2 Plus GB Cordless Drill



Includes

- 2 airstream battery packs
- 1 rapid charger
- CENTROTEC tool chuck
- CENTROTEC bit holder

Festool CXS Li 2.6 Set GB Cordless Drill



Includes

- 2 battery packs BP-XS
- charger MXC
- CENTROTEC tool chuck
- CENTROTEC bit holder
- FastFix keyless chuck 10 mm
- XS elbow adapter
- bit PZ 2
- in SYSTAINER SYS 1 T-LOC

Festool Centrotec Pozidrive Bit Box + BH 60-CE



Festool Centrotec Bits



A - PZ 1-25 / 2-25 / 3-25
B - Holder BH60-CE
C - Holder BV150-C Extra Long



Festool OF 1010 Guide Rail Adapter
Complete with support, for use of routers with the FS guidance system, without rods.



Festool Guide Rail FS 1400
Safe, perfectly straight power tool guidance, splinterguard for splinter-free sawing, length 1400mm.



Festool OF 1400 Guide Rail Adapter
With fine adjustment and support for router without guide rods, without rods.



Festool EHL 65
Replacement Blade.



Festool EHL 65
Dust Bag.

Festool OF 1010 EBQ Plus
110/240V



Includes

- chip deflector
- Ø1/4" clamping collet
- side stop
- open ended spanner, WAF 24
- guide rail adapter
- in SYSTAINER SYS 3 T-LOC

For routing profiles, grooves, rebates and dovetail joints and routing depth adjustment to 1/10mm.

Festool OF 1400 EQ-Plus
110/240V



Includes

- chip deflector
- Ø1/4" & Ø1/2" clamping collet
- side stop with fine setting
- copying ring Ø 30 mm
- extraction hood, top
- open ended spanner, WAF 24
- in SYSTAINER SYS 4 T-LOC

70 mm routing stroke and routing depth adjustment to 1/10mm.

Festool EHL 65 EQ Plus Planer
110/240V



Includes

- parallel side fence
- hex key, WFA 2
- in SYSTAINER SYS 2 T-LOC

Maximum 4mm planing depth and 23mm rebate depth for more speed and flexibility. Efficient dust extraction at the left/right side no clean-up needed.

Festool Domino DF500 Q-Plus Joiner
110/240V



Includes

- DOMINO cutter D5
- open ended spanner, WAF 8
- in SYSTAINER SYS 2 T-LOC

Varied use with dowel sizes from 4 x 20mm to 10 x 50mm.

Festool PS420 Angle Table



Base for mitre, undercuts, and angled cuts from +45° to -45°, stepless angle adjustment, fits Festool 400/420 jigsaws.

Festool Pendulum Jigsaw Trion PS300
110/240V



Includes

- patented three-way saw blade guide for cutting precise angles
- splinterguard
- in SYSTAINER SYS 1 T-LOC

Festool Domino XL DF700 Joiner
240V



Includes

- DOMINO cutter D12
- empty dowel box
- open ended spanner, WAF 12
- in SYSTAINER SYS 5 T-LOC

Maximum stability of joints up to a DOMINO size of 14 x 140mm.

Festool Carvex PS420 EBQ-Plus Jigsaw
110/240V



Includes

- saw blade
- splinterguard
- in SYSTAINER SYS 1 T-LOC

Low weight 1.9 kg.

Festool Carvex PSBC420 EB-Plus Cordless Jigsaw



Includes

- saw blade
- splinterguard
- BP 18 Li 5.2 AS battery pack
- SCA 8 rapid charger
- in SYSTAINER SYS 2 T-LOC

Low weight 2.4 kg.

**Festool Cleantex CTL 26
Mobile Dust Extractor**
110/240V



- Includes
- SELFCLEAN filter bag
 - smooth suction hose dia. 27/32 x 3.5 m AS/CT
 - hose and cable holder
 - SYS-Dock with T-LOC function
 - bluetooth® module for remote control on the suction hose or automatic start via the bluetooth® battery pack
- Container/filter bag capacity 26/24L

See page 89 for cleaning sets

**Festool CTL Midi Bluetooth®
Mobile Dust Extractor**
110/240V



- Includes
- bluetooth® functionality for extractor, remote swith-on for cordless tools
 - hose and cable holder
 - SELFCLEAN filter bag
 - smooth suction hose dia. 27/32 x 3.5m AS/CT
 - SYS-Dock with T-LOC function
- Container/filter bag capacity 15/12.5L

Festool CTL SYS Extractor
230V



- Includes
- fitted filter bag
 - suction hose
 - hose holder
 - SYS-Dock with T-LOC function
- Approval for dust class L, only suitable for dry extraction, container/filter bag capacity 4.5/3.5L

**Festool Rotex RO90
DX FEQ-Plus**
110/240V



- Features
- FastFix sanding pad system, tool-less
 - Sanding up to the edge thanks to the Festool PROTECTOR
 - Four tools in one: for coarse/fine/delta sanding and polishing. Resulting in low investment costs and savings on working time
 - weight <1.5 kg

**Festool Rotex RO125
FEQ-Plus**
240V



- Features
- FastFix sanding pad Ø 125 mm (soft-HT)
 - Sanding up to the edge thanks to the Festool PROTECTOR
 - in SYSTAINER SYS 2 T-LOC
 - weight <1.5 kg

**Festool Rotex RO150
FEQ-Plus**
110/240V



- Features
- MULTI-JETSTREAM 2 FastFix sanding pad Ø 150 mm (soft W)
 - Sanding up to the edge thanks to the Festool PROTECTOR
 - in SYSTAINER SYS 3 T-LOC



- Festool Sanding pad RO90 DX**
Delta sanding pad plate for attaching StickFix sanding pads soft and hard.



- Festool RO90 Delta Backing Plate**
Component with StickFix coating onto which sanding pad is secured.



- Festool RO90 Delta Sanding Pad**
Soft/Hard
StickFix adhesive layer for quick change of sanding pad, hard or soft versions with snap stud.



- Festool CT 26 Dust Extractor Longlife Bag**
Used for extraction of dust types not hazardous to health and not recommended for fine dust.



- Festool CTL Midi Longlife Filter Bag**
Used for extraction of dust types not hazardous to health and not recommended for fine dust.



- Festool Rotex RO125 Pad**
Ultra Soft/Soft/Hard



- Festool Rotex RO150 Soft Sanding Pad**
FastFix, soft version. For universal use on plain and arced surfaces.



- Festool Rotex RO150 Hard Sanding Pad**
FastFix, hard version. High edge solidity, for plain surfaces and narrow edges.



- Festool CT 26 Dust Extractor Filter Bag**
For extracting dust with the CTL26 with Autoclean function.



- Festool Selfclean Midi Filter Bag Original/New Model**
High-quality cloth filter bag, cleans dust deposits inside the filter bag automatically.

Festool Kapex KS88 RE GB Sliding Compound Mitre Saw
110/240V



Includes

- HW universal saw blade W60
- workpiece clamp
- hex key, WAF 6
- in carton

FastFix saw blade changing for adaptation to the working material with twin-column guide for accurate cuts.

Festool Kapex KS120 EB Sliding Compound Mitre Saw
110/240V



Includes

- HW universal saw blade W60
- bevel
- workpiece clamp
- operation tool
- in carton

FastFix saw blade changing for adaptation to the working material with twin-column guide for accurate cuts and Safety brake.

Festool Kapex Underframe Complete set



Features

- convenient transport on building and installation sites
- simple folding in for transport
- Simple fitting of trimming attachments
- Integrated meas. scale and adjustable stop permit exact repeat cuts
- weight 21.00kg
- work height 900mm

Festool Kapex Underframe



Features

- convenient transport on building and installation sites
- simple folding in for transport
- weight 13.00kg
- work height 900mm

Festool 4m Plug IT Cable
rubber insulated cables
110V Yellow
240V Green



Festool Precisio CS50 EB-SET Complete set
110/240V



Includes

- HW universal saw blade W32
- angle stop
- ripping-cut fence
- sliding table
- extension table
- extension table
- foldaway legs
- splinterguard
- dust extraction set
- workpiece holder
- operation tool

Festool Systainer
Box 2
Dimensions (L x W x H)
396 x 296 x 157.5mm
Weight 1.50kg
• 1x cover for label field



Festool Sortainer
Dimensions (L x W x H)
396 x 296 x 210mm
For storage in drawers: Small parts such as nails, dowels or screws can be stored just as neatly as hand tools.



Festool Systainer
Box 3
Dimensions (L x W x H)
396 x 296 x 210mm
Weight 1.80kg
• 1x cover for label field



SYS-Roll



- transportation of SYS Classic and SYS T-LOC
- extra large wheels (D 200mm)
- for easy transportation up and down steps
- rotating lockable front rollers - manoeuvre in all directions

Festool Systainer
Box 4
Dimensions (L x W x H)
396 x 296 x 315mm
Weight 2.10kg
• 1x cover for label field



Festool Compact Cleaning Set



- curved hand tube D 36 HR-K AS
- extension pipes D 36 VR-K AS
- 4-piece floor nozzle D 36 BD270
- crevice nozzle D 36 FD-210
- in SYSTAINER SYS 1 T-LOC

Festool Systainer
Box 5
Dimensions (L x W x H)
396 x 296 x 420mm
Weight 2.70kg
• 1x cover for label field



Festool Tradesman Cleaning Set



- smooth suction hose D 36
- curved hand tube D 36 HR-K AS
- extension tube, special steel 3-piece D 36 VR-M3x
- crevice nozzle D 36 FD-210
- suction brush D 36 SP
- in SYSTAINER SYS 5 T-LOC



Chalk Hog
30m/100ft & 4.oz
Blue Chalk



Chalk Refill
227g (8oz) Blue



Screeding Trowel Soft Grip Handle
14in x 4in



Hanson Hard Lead Pencil



Euro Filling Knives



Filler & Spreader Set
Stainless Steel



Irwin Marples MS500 All Purpose Chisel
ProTouch Handle

For sanding and polishing accessories see pages 134-137



Irwin 990UHP Fine Handsaw
550mm 9tpi
Soft Grip



Irwin 770UHP Coarse Hardpoint Handsaw
550mm 7tpi
Soft Grip



Scangrip Nova 3KC+R Work Light



Superbar 380mm t
With 'Shepherd's Crook' rocker head for max prying power. Perfect for prying mouldings, scraping and pulling nails.



Roughneck Tapping Block
480mm - Designed to knock wood flooring planks together in order to ensure perfect fitting. Use with a mallet.



Roughneck Pulling Over Tool
520mm - Pulls wood flooring planks together to ensure a neat flush finish.



Estwing Straight Claw Hammer Vinyl Grip
560g (20oz)



Bosch Jigsaw Blades
T101AO
T101D
T144D



Bessey AV2 Adjustable Floor Spacer
For 5-20mm expansion gap
Easy to remove



Bessey SVH400 Ratchet Flooring Clamp
4m



Nail Punch
Yellow - 0.8mm 1/32 in
Blue - 1.6mm 1/16 in
Red - 2.4mm 3/32 in



Roughneck Nail Punch
Yellow - 0.8mm 1/32 in
Blue - 1.6mm 1/16 in
Red - 2.4mm 3/32 in



TCT Scraper
20mm
Soft Grip Handle

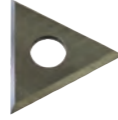

TCT Scraper Replacement Blade



Bahco 650 Power Scraper



Bahco 665 Paint Scraper



Wooden Handled Folding Pocket Knife



Bahco 442 Scraper Blade



Recoil Knee Pads
Scientifically proven to reduce peak pressures on the knee by up to a staggering 76%



For all other Recoil Knee pad accessories give us a call!



Recoil Knee Pad Replacement Covers
Suitable for all existing knee pad types.



WFA 10m Tape Measure



Maxvac DV-20 LB L Class Vacuum
Including Floor Bar, Hose and Tools 100/240V.

The Maxvac Dura DV-20-LB 110v/240v is a single motor vacuum and has wet and dry capability, with a 20ltr drum it is highly versatile and useful in many scenarios.

It has up to 1300watt power take off with auto run and filter clean with a dual power motor. Fitted with castors using non-mark wheels means it can be used on a variety of surfaces. The drum is extremely tough and can withstand the toughest of treatment, the motor housing is also very tough and can withstand impact.

Includes (also sold separately)

- Industrial Bar Insert for Carpet
- Industrial Brush Insert for Floors
- Industrial Rubber Bar Insert for Liquids
- Replacement L Class Filter, DV20/35
- Crevice Tool, 45mm
- Round Brush
- Suction Hose with Swivel Connections 2.5m x 45mm, DV20/35
- Suction Hose with Stepped Power Tool Adaptor, 4.0m x 36mm, DV20/35
- Floor Bar Housing
- 45mm Plastic Wand for Dura Range 2pcs set

FILTER CLASS



Features

- Power take off - up to 1300w
- Reduces need for extension leads and power supplies
- Filter type - cartridge
- Power cord length - 7m
- Capacity - 20ltrs
- Dimensions (L x W x H) - 410 x 420 x 600mm
- Weight - 9.6kg



Maxvac Dura Assembly Drum Fleece Bags, L Class



Maxvac Waletale
Dust control bucket fitting with 6mm groove, for screed mixing bucket.



Maxvac Stepped Power Tool Adaptor
Use this adaptor to attach the hose to most Festool tools.

FESTOOL



Leica DISTO D2-BT Laser Distance Measurer with Bluetooth



The D2 measures from its base by default and can be configured to measure from the front.

- Range up to 100m
- Press a button & get an instant measurement on screen
- Typical accuracy +/-1.5mm
- 10 Value memory
- IP54 dust & splash water protected
- Multi-functional endpiece - fits into corners for accurate diagonal measurements

The endpiece is an integral part of the tool, connected to the circuit board. In the closed position the DISTO™ knows to measure from its base. Flip it open 90 degrees to align the base perfectly on an edge or corner. Flip it out all the way and you can put this baby in a corner to accurately measure diagonals. Otherwise, the width of the base would prevent you from getting all the way into the corner, rendering the measurement inaccurate.

Leica DISTO X3 Rugged Laser Distance Measure with Bluetooth



The Leica DISTO X3 is perfect for tough construction site conditions. It is drop-tested up to 2 m in height, water jet and dust protected to IP 65 standards.

It allows you to measure distances between any two points from one position.

- Range up to 150m
- Tilt sensor
- Typical accuracy +/-1mm
- 20 Value memory
- IP65 dust tight & water jet protected
- Multifunctional end piece with auto recognition

The Leica DISTO™ X3 display automatically rotates in line with the measurement direction. This means you can always read your measurement results from any angle. This device is designed to make indoor laser measurements an easy task. A holster, hand loop and batteries are included.

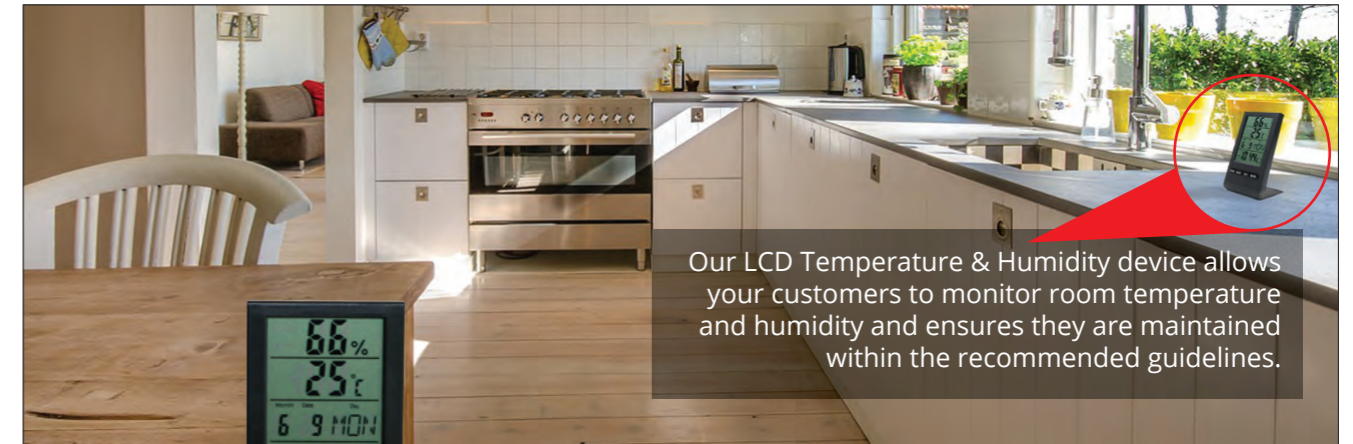

LCD Thermometer & Hygrometer

- Temperature measuring range - 0 - 60°C
- Humidity measuring range 20% - 95%
- Memory of minimum & maximum value for readings

Educating your customers and reducing complaints.

By identifying when the readings are too high or low your customer will be able to notify you before problems arise or get any worse.

Delivery...

ORDERS FOR STOCK ITEMS PLACED BEFORE 3PM ON MACHINERY & ACCESSORIES

Standard Next Day - Business Hours **FREE** on orders over £150 +VAT
 Standard Next Day - Business Hours **£10.00** +VAT on orders below £150 +VAT

EXPRESS DELIVERY COSTS

Next Day - Before 10.30am **£30.00** +VAT Before 12.00pm **£25.00** +VAT
 Saturday - Before 10.00am **£40.00** +VAT

NOTE: The above prices exclude deliveries for RECLAIMED FLOORBOARDS, BATTENS - dependent on quantity, UNDERLAYS, PRO CARD, PLYWOOD, HARDBOARD AND SOME ADHESIVES. These products will be quoted per order due to either their size, weight or flammability properties.

Sales 020 8501 6730

Delivering 6 days a week

*Subject to delivery terms



Protimeter - Timbermaster Standard Kit
Includes

- Heavy duty probe
- Calibration check device
- Zip Pouch
- Calibration chart - 150 species
- 2 x AA batteries



Protimeter - MMS 2
Includes

- Quikstick Short
- Heavy duty moisture probe
- Calcheck device
- Operators Instructions
- 9v battery
- Pouch

For testing moisture in timber, concrete and atmospheric conditions.



Protimeter - Mini Moisture Meter
20 Coloured lights to indicate moisture level in timber.

Includes

- Extension pin probe
- Calcheck device
- Pouch with belt loop
- 2 AA batteries



Protimeter - Surveymaster
Includes

- Protimeter Surveymaster
- Protective Pouch
- 2 x AA Batteries
- Heavy Duty Extension lead
- 120mm Deep Wall Probes
- Self Calibration Check
- Wood Species Chart

Scan search for moisture in walls/floors to a depth of approx 19mm.



Protimeter - Humidity Sleeve
16 x 43mm humidity sleeves for Protimeter MMS 2 or Hygromaster. Use to measure equilibrium RH value of walls and floors by inserting into predrilled holes.



Protimeter - Aquant
Includes

- Protimeter Aquant
- Protective Pouch
- 2 x AA Batteries

Scan search for moisture in walls/floors to a depth of approx 19mm.

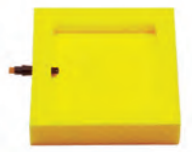

Protimeter - Humidity Box
Allows surface RH tests on concrete subfloors.

Tramex PTM 2.0 & HH14TP30 Wood Inspection Kit
Pin type moisture meter for wood, 6 - 46% digital readout to 0.1% accuracy. Calibration for 500+ wood species.

Built-in calibration for 500+ wood species and international standard calibrations.



Tramex Flooring EZ Kit CME II
Digital version of the Tramex CME 4, for fast, non-invasive and accurate moisture content measurements in solid floors and screeds including concrete.

- Fastest, most reliable, Hygro-i @ RH probe for testing to BS 8201 & ASTM F2170.
- Instant concrete moisture content test from 0 - 6.9% with CME II to ASTM F2659



Tramex Infrared Surface Thermometer
Features a laser target pointer to gain instant readings on almost any surface from a distance.



Tramex Pin Type Wood Probe HH14TP30
Wood probe with cable & pins for use with CME II, MRH3 & PTM.



Tramex CME 4 Concrete Encounter
Instant test for concrete with precise readings to a depth of approx. 20 mm (¾") into the slab.



Tramex Hygrohood Tape
15m Roll



Tramex Hygrohood with Tape
Non-destructive relative humidity testing of concrete flooring slabs and screeds. Ideal for use with the Tramex CME 4.



Tramex Humidity Box
For testing RH in concrete. Use in conjunction with CMEXpert kit.

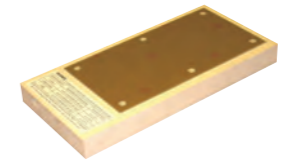



Tramex Calibration Check Plate
Ideal for use with the Tramex CME 4.

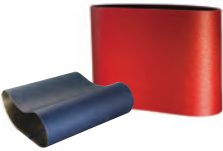

Bulk discounts available on Hermes call for details





Belts	Unit	Zirconia	Ali Oxide
8" / 200mm x 750mm Cloth Belts			
 16G Hermes 200 x 750 Cloth Belts	10		
24G "	10		
36G "	10		
40G "	10		
50G "	10		
60G Commonly purchased for the;	10		
80G Lagler Elf, Hummel & Profit	10		
100G "	10		
120G "	10		
10" / 250mm x 750mm Cloth Belts			
 16G Hermes 250 x 750 Cloth Belts	10		
24G "	10		
36G "	10		
40G "	10		
50G "	10		
60G Commonly purchased for the;	10		
80G Bona Belt	10		
100G "	10		
120G "	10		

Velcro Orbital Discs	Unit	Price
Festool R090		
 40G Hermes Festool R090 Velcro Discs 7 Hole		
60G "		
80G "		
100G "		
Festool R0125		
 40G Hermes Festool R0125 Velcro Discs 9 hole		
60G "		
80G "		
100G "		
Festool R0150		
 40G Hermes Festool R0150 Velcro Discs 9 hole		
60G "		
80G "		
100G "		
120G "		
150G "		





Hermes Discs	Unit	Zirconia	Silicon Carbide
			
16G Hermes Velcro Discs - 150mm	50		
24G "	50		
36G "	50		
40G "	50		
50G Commonly purchased for the;	50		
60G Bona Edger, FlexiSand & Mini	50		
80G Lagler Elan & Flip Edge Sander	50		
100G "	50		
120G "	50		
			
16G Hermes Velcro Discs - 180mm	50		
24G "	50		
36G "	50		
40G "	50		
50G Commonly purchased for the;	50		
60G Bona Edger - K&T Pegasis	50		
80G Lagler Unico	50		
100G "	50		
120G "	50		
			
16G Hermes Velcro Discs - 200mm	50		
24G "	50		
36G "	50		
40G "	50		
50G Commonly purchased for the;	50		
60G Bona Edger - K&T Pegasis	50		
80G Lagler Trio	50		
100G "	50		
120G "	50		

Screening Mesh Discs	Unit	Price
 60/80/100/ 17" Hermes Buffing Mesh Discs		
120/150G		

Polishing Pads	Unit	Price
 Red Non G 17" Hermes Buffing / Polishing Pad		
White Non G "		
Black 80G "		



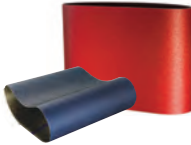
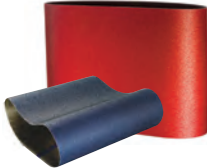

8"/203mm + 12"/3-5mm Rolls - available to order



Belts	Unit	Zirconia	Ali Oxide
8" / 200mm x 750mm Cloth Belts			
 16G..... Bona 200 x 750mm Cloth Belts	10		
24G..... "	10		
36G..... "	10		
40G..... "	10		
50G..... "	10		
60G..... Commonly purchased for the;	10		
80G..... Lagler Elf, Hummel & Profit	10		
100G.....	10		
120G.....	10		
10" / 250mm x 750mm Cloth Belts			
 16G..... Bona 250 x 750mm Cloth Belts	10		
24G..... "	10		
36G..... "	10		
40G..... "	10		
50G..... "	10		
60G..... Commonly purchased for the;	10		
80G..... Bona Belt	10		
100G..... Lagler Super Hummel	10		
120G.....	10		
8" / 200 x 550mm Cloth Belts (Flexi Drum) Ali Oxide only			
 16G..... Bona 200 x 551mm Cloth Belts	10		
24G..... "	10		
36G..... "	10		
40G..... "	10		
50G..... "	10		
60G..... Commonly purchased for the;	10		
80G..... Bona Flexidrum	10		
100G.....	10		
120G.....	10		



Bona Discs	Unit	Zirconia	Silicon Carbide
 16G..... Bona Velcro Discs - 150mm.....	50		
24G..... "	50		
36G..... "	50		
40G..... "	50		
50G..... Commonly purchased for the;	50		
60G..... Bona Edger, FlexiSand & Mini	50		
80G..... Lagler Elan & Flip Edge Sander	50		
100G.....	50		
120G.....	50		
 16G..... Bona Velcro Discs - 178mm.....	50		
24G..... "	50		
36G..... "	50		
40G..... "	50		
50G..... Commonly purchased for the;	50		
60G..... Bona Edger - K&T Pegasis	50		
80G..... Lagler Unico	50		
100G.....	50		
120G.....	50		
 16G..... Bona Velcro Discs - 200mm.....	50		
24G..... "	50		
36G..... "	50		
40G..... "	50		
50G..... Commonly purchased for the;	50		
60G..... Lagler Trio	50		
80G.....	50		
100G.....	50		
120G.....	50		
 16G..... Bona Double Sided Sanding Disc 16".....	Each		
24G..... "	Each		
36G..... "	Each		
40G..... "	Each		
50G..... Commonly purchased for the;	Each		
60G..... Bona Buffer & FlexiSand	Each		
80G.....	Each		
100G.....	Each		
120G.....	Each		

Bona Discs		Unit	Price
	60G 16" Bona Mesh Discs	Each	
	80G	Each	
	100G	Each	
	120G	Each	
	150G	Each	
Commonly purchased for the; Bona Buffer & FlexiSand			
	Red - for spray-cleaning 11" Bona Cleaning Pads	Each	
	Tan - for polishing..... "	Each	
	White - for backing of sanding screen or polishing ... "	Each	
	Commonly purchased for the; Bona Mini Buffer		
	Red - for spray-cleaning 16" Bona Cleaning Pads	Each	
	Tan - for polishing..... "	Each	
	Green - for wet cleaning	Each	
	White - for backing of sanding screen or polishing ... "	Each	
Commonly purchased for the; Bona Buffer			
16" Bona Scrad Pad.....	Each.....	
Commonly purchased for the; Bona Buffer & FlexiSand			
	150G Bona Scrad Wings	50	
Commonly purchased for the; Bona Buffer & FlexiSand			





Adesiv Pelpren PL6 10kg
2 component, beige and brown epoxy/PU for gluing 10mm parquet flooring to concrete/timber. Compatible with underfloor heating.
Coverage Approx 1kg/m²



Adesiv Pelpren R-R 1kg
2 component, water-free polyurethane adhesive for the rapid gluing of any kind of wood floor repair/small area to concrete/timber.



Adesiv WB Mono MS 600ml
Flexible adhesive for gluing all types of wood floors to concrete/timber. Compatible with underfloor heating
Coverage Approx 1m²



Adesiv WB Mono MS 15kg
Flexible adhesive for gluing all types of wood floors to concrete/timber. Compatible with underfloor heating
Coverage Approx 12m²



Adesiv Adegloss 10 250ml
Injectable PU Adhesive. This is a hygro-hardening expanding polyurethane resin, used before and after the installation of flooring. It has a **UNIQUE** swelling characteristic that allows the filling of empty spaces.

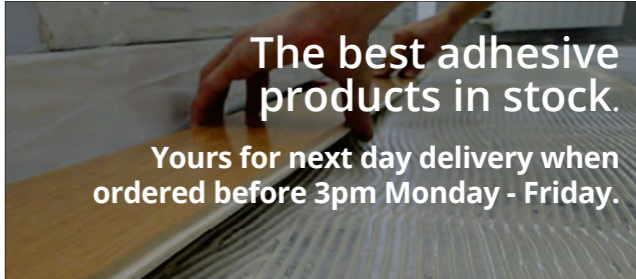

The best adhesive products in stock.
Yours for next day delivery when ordered before 3pm Monday - Friday.

ACCESSORIES

Delivery.. **ORDERS FOR STOCK ITEMS PLACED BEFORE 3PM ON MACHINERY & ACCESSORIES**

Standard Next Day - Business Hours **FREE** on orders over £150 +VAT
Standard Next Day - Business Hours **£10.00** +VAT on orders below £150 +VAT

EXPRESS DELIVERY COSTS
Next Day - Before 10.30am **£30.00** +VAT Before 12.00pm **£25.00** +VAT
Saturday - Before 10.00am **£40.00** +VAT

NOTE: The above prices exclude deliveries for RECLAIMED FLOORBOARDS, BATTENS - dependent on quantity, UNDERLAYS, PRO CARD, PLYWOOD, HARDBOARD AND SOME ADHESIVES. These products will be quoted per order due to either their size, weight or flammability properties.

Sales 020 8501 6730
Delivering 6 days a week

*Subject to delivery terms



For next day delivery of Bona adhesives call and **order before 10am****Bona**[®]
Passion for wood floors**Bona R850 Adhesive 15kg**

A hard-elastic 1 component silane adhesive. Suitable for all types of wood flooring. Its hard-elastic properties make it strong and resistant against movement of wood while relieving tension on the sub floor. Compatible with underfloor heating.
Coverage 850-1500g/m²

**Bona R848 Adhesive 15kg**

An elastic 1 component silane wood floor adhesive. A high performance formulation that is ideal for the installation of engineered wood flooring. Can also be used for solid boards up to 190mm wide. Compatible with underfloor heating.
Coverage 850-1250g/m²

**Bona R590 Silane Based Moisture Barrier 8kg**

A water and solvent free silane-based compound for priming and/or sealing residual moisture in the substrate. For reinforcing weak subfloor surfaces up to a certain level. Flooring can be installed as soon as 4-6 hours after application. Compatible with underfloor heating.
Coverage 500-1000g/m²

The most effective wood floor adhesives give you the right combination of strength and elasticity. Choose an adhesive from the Bona system that's just right for your installation.
For **Bona** products order before 10am for NEXT DAY DELIVERY.

**Bona R410 Primer/Moisture Barrier 5kg**

A solvent and water-free, 2 component epoxy resin, suitable for damp proofing concrete or cement subfloors – or for use as a primer prior to the application of a suitable adhesive or levelling compound. Two coats are required when used as a damp proofer – allow 3 hours between coats. Drying time: 24 hours.

**Bona Titan 15kg**

A silane based adhesive, it has a 'quadruple crosslinking' formulation that delivers ultimate durability and the fast possible bonding. Keeps even the largest solid boards in place. No discolouration or hollow spots. No primer required.
Coverage 850-1500g/m² depending upon type of flooring being installed.

WAKOL[®]**Wakol MS260 Plus Adhesive 18kg**

Firm-flexible, premium 1 component MS Polymer adhesive for gluing T&G flooring to concrete/timber. Can be used with underfloor heating.
Coverage Approx 12-14m²/unit

**Wakol MS228 Ready-To-Lay Parquet Adhesive 18kg**

Elastic, 1 component parquet adhesive for engineered floors only, for laying on absorbent and non-absorbent subfloors. Can be used with underfloor heating.
Compatible with MS330 only.
Coverage Approx 12-14m²/unit

**Wakol MS230 Adhesive 18kg**

Flexible, premium 1 component MS Polymer adhesive for gluing engineered flooring to concrete /timber. Can be used with underfloor heating.
Coverage Approx 12-14m²/unit

**Wakol 4535 Additive 0.15kg (Brown)**

Brown colour paste to stain PU225 Adhesive below.

**Lecol 5500 Adhesive Spirit Based 16kg/25kg**

Water free, spirit based rigid set adhesive for wood blocks, plywood, mosaic panels and parquet up to 90mm wide.
Coverage Approx 12m²/16kg
Coverage Approx 19m²/25kg

**Wakol PU225 Adhesive 6.75kg (Beige)**

2 component PU For gluing 10mm parquet flooring and mosaics. Can be used with underfloor heating.
Coverage Approx 6m²/unit



Wakol MS262 Adhesive Sausage 600ml
Solvent free modified saline adhesive for engineered & solid wood flooring up to 180mm. Suitable for underfloor heating. Coverage Approx 1m²/sausage



Bona R880 Silane Based Adhesive 310ml
Ready to use, fast drying, silane based adhesive suitable for the installation of stair nosings, skirting boards, door thresholds etc. Solvent free. Coverage Approx 9 lin m/tube



Adhesive Syringe Assembly (Luer Lock)
20ml Graduated



Adhesive Syringe Tip (Luer Lock)
14G 25mm SE Tip



Lecol TS160 Slotted Acoustic Underlay 3mm
15m² roll, for use with the above MS262 adhesive. See page 140 for full details.



Strong Grip Fast Action Panel Adhesive 350ml
Enhanced slump resistance for quick and simple direct bonding to most substrates without the use of temporary supports in most applications. Coverage Approx 10 lin m/tube



Adhesive Syringe Cap Seal
Black



General Paddle Whisk/Mixer
80 x 400mm

See pages 140 and 141 for our full range of underlays.



Lumberjack 5 Minute PU Adhesive Gel 310ml
Waterproof, thixotropic, transparent, gap filling gel, sets hard in just 5 minutes. Particularly suitable where rapid bonding is required. Coverage Approx 10 lin m/tube



Manual Adhesive Bulk Gun Applicator



Adesiv P6 Trowel
P6 (for T&G Blocks/Strip)



Lecol PVAC 0.75kg
PVA joint adhesive for floating floors. Great general purpose wood adhesive. Coverage Approx 25 lin m/ bottle when joint gluing



Mitre Fast Adhesive Kit
A two part instant adhesive system. Bonds most surfaces within 10 seconds.



Power Pro Gun
310/400ml



Lecol Wide Notched Trowel
P69 (for Parquet)



EXPERTS IN ACOUSTIC INSULATION, SOUND ABSORPTION AND REVERBERATION

CMSDanskin Acoustics soundproofing solutions have dramatically reduced airborne and impact noise in schools, theatres, churches, libraries, a host of residential projects and MORE!

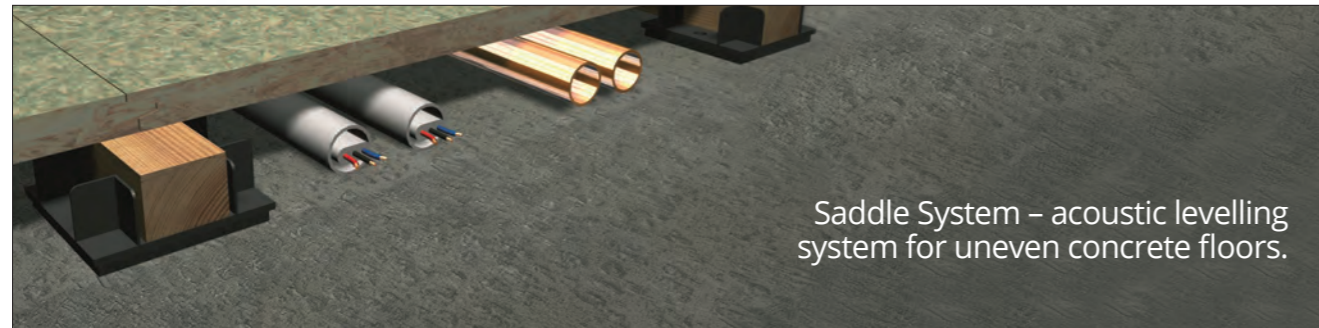

Saddle System – acoustic levelling system for uneven concrete floors.



Acoustic Saddles
97mm x 97mm
The saddles are available in three head cap heights S, M, L. The small saddle permits 14mm of packing, the medium - 29mm and the large - 40mm.

11mm



Regupol 4515 Eco Underlay
For concrete floors, material construction rubber/cork and suitable for underfloor heating.
3mm - 17dB
4.5mm - 18dB
Roll width 1.1m

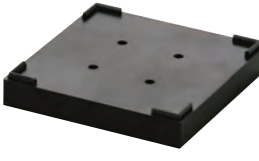

Elevating Blocks
15mm Box of 432
30mm Box of 216
Can be placed in combination below saddles where floor variations are extreme up to a maximum height of 150mm.



Packers
Boxes of 500 per size
Self locating plastic packers in 2, 3, and 5mm thicknesses. They interlock with each other and with the Saddle to achieve the levelling of uneven subfloors.

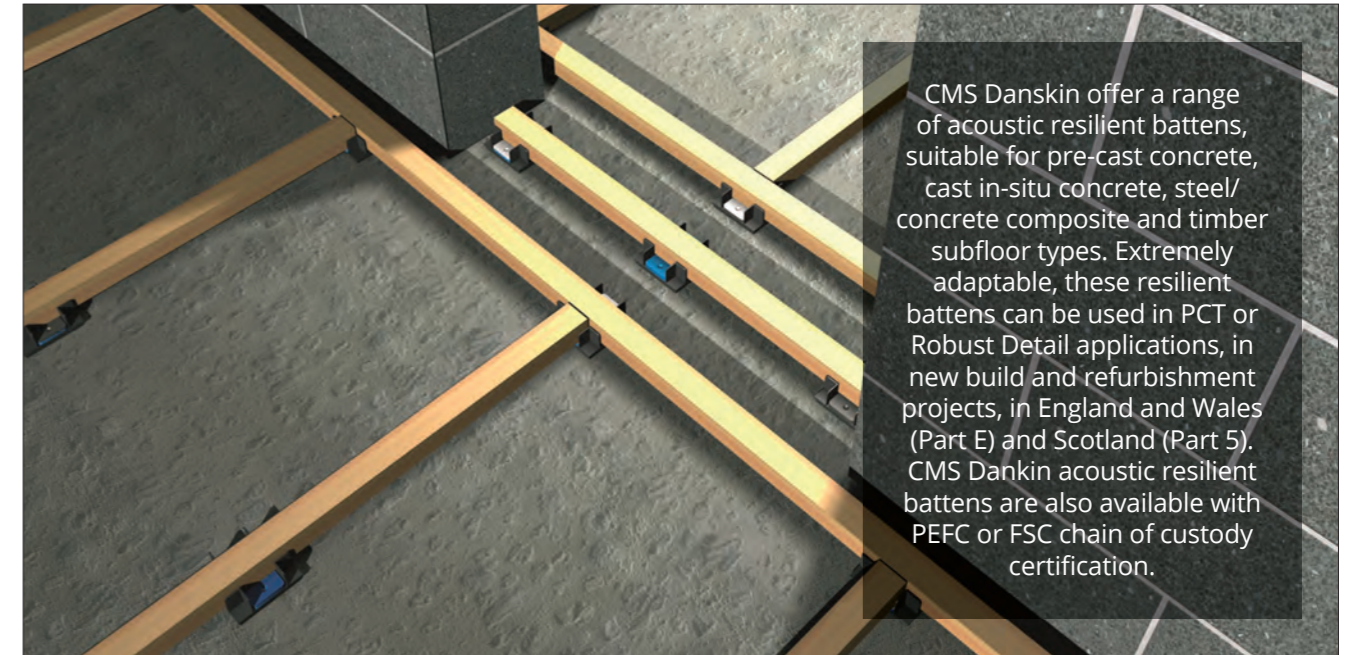

CMS Danskin offer a range of acoustic resilient battens, suitable for pre-cast concrete, cast in-situ concrete, steel/concrete composite and timber subfloor types. Extremely adaptable, these resilient battens can be used in PCT or Robust Detail applications, in new build and refurbishment projects, in England and Wales (Part E) and Scotland (Part 5). CMS Danskin acoustic resilient battens are also available with PEFC or FSC chain of custody certification.

See pages 24 - 45 for Truly Bespoke Flooring and pg 132 for 18mm Chipboard

CMS Danskin Softwood Batten Foam Backed

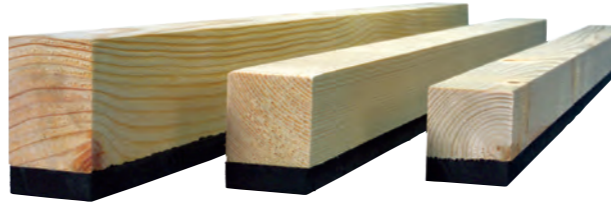

CMS Danskin Softwood Battens

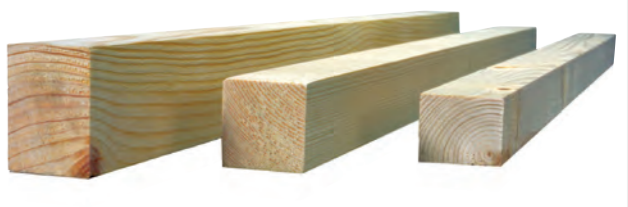



EXCLUSIVE UK DISTRIBUTOR

Adesiv Legastucco L100 Resin Filler 10kg
Quick-drying solvent-based binding resin for mixing with wood powder to grout and smooth parquet floors. Can be painted over.
Coverage 2-4m²/1kg

lecol - 7500 Filler
To be mixed with fine abrasion dust from the wood in order to obtain a paste that can be used to fill small voids in parquet or other wooden floors.
Coverage 2-4m²/1kg

Stopgap Clear Roll - Clear or Brown 40m
Solution for draughty floorboards, reduces draughts and provides a base for filler, fast and easy to fit. V-shape in design, this is the clever bit, as the v-shape means the strip is now springy. It will grip the sides of the gap it is pushed into, holding it in securely.

These colours are available to order

OSMO Wood Filler 250g
Putty compound for use with engineered flooring.

•	Beech
•	Cherry
•	Ebony
•	Jatoba

•	Mahogany
•	Maple/Birch
•	Natural Clear
•	Pine/Spruce
•	Antique Oak
•	Mid Oak
•	White Oak
•	Teak
•	Walnut
•	White

Osmo Repair Set
For Wood/Laminate Floors -

•	143
•	156
•	157
•	165
•	303
•	900

Osmo Gap Sealer 310ml
For Wood/Laminate Floors -

•	Black
•	Grey
•	Light Oak
•	Medium Oak
•	Dark Oak
•	Pine/Spruce
•	Redwood
•	Walnut
•	White

Bona Gap Master 310ml
PU 'Mastic Type' Filler. Silicone free mastic, designed for filling gaps between parquet blocks, around skirting boards and door thresholds.
Based on a polyacrylate compound the material can be sanded and overcoated with floor finishes.

•	Ash/Fir (Pine)
•	Light Beech
•	Dark Beech
•	Black
•	Cherry
•	Grey
•	Maple (Light Ash, Birch)
•	Bog Oak
•	Dark Oak
•	Light Oak
•	Nut
•	Red Exotic Wood
•	Teak
•	Wenge
•	White

Bona Mix&Fill
Water based filler for mixing with fine sawdust. Ideal for filling joints, gaps and minor defects up to 2mm in width. Offers a good colour match with the surrounding wood. Quick drying and easy to sand.
Coverage 5-10m²/1ltr

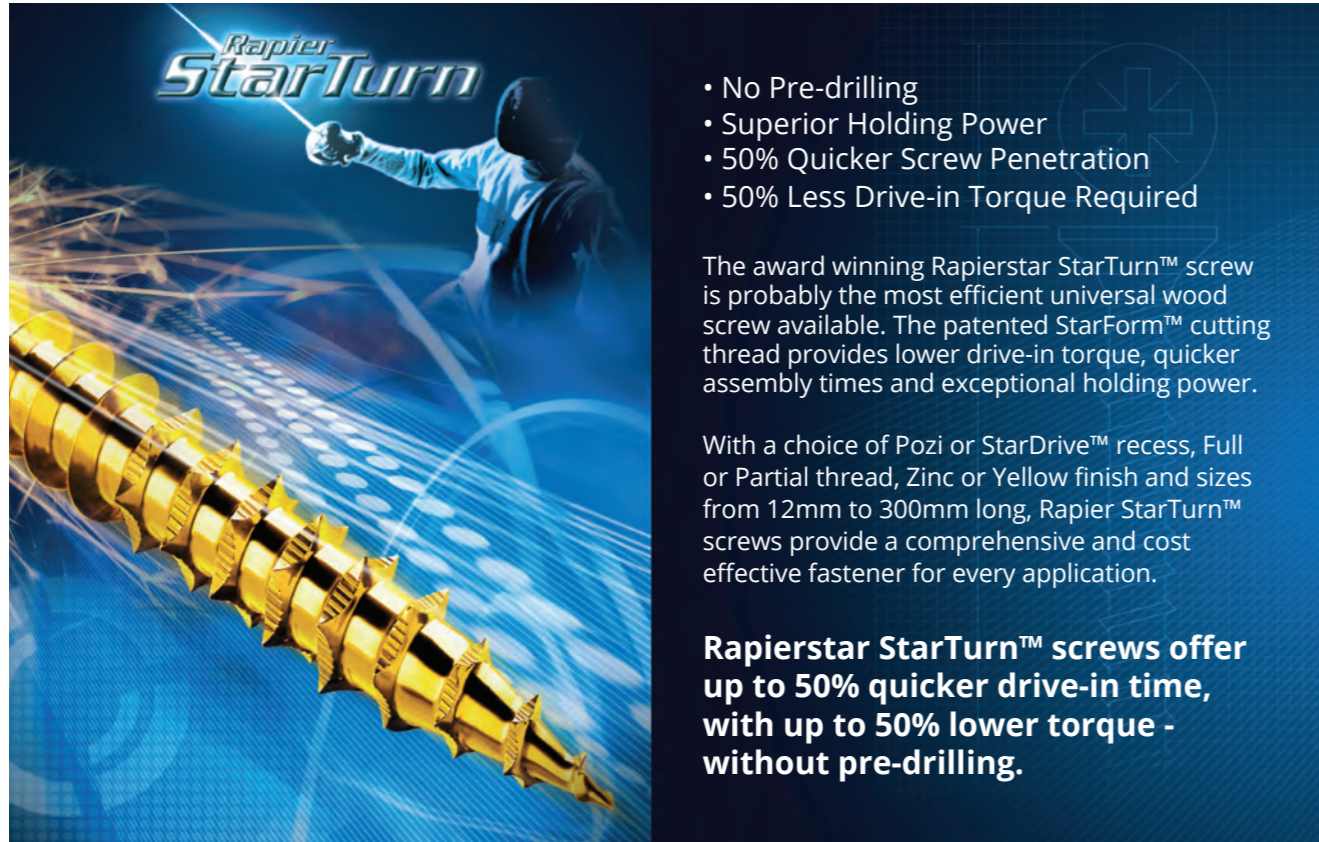

Rapier StarTurn

- No Pre-drilling
- Superior Holding Power
- 50% Quicker Screw Penetration
- 50% Less Drive-in Torque Required

The award winning Rapierstar StarTurn™ screw is probably the most efficient universal wood screw available. The patented StarForm™ cutting thread provides lower drive-in torque, quicker assembly times and exceptional holding power.

With a choice of Pozi or StarDrive™ recess, Full or Partial thread, Zinc or Yellow finish and sizes from 12mm to 300mm long, Rapier StarTurn™ screws provide a comprehensive and cost effective fastener for every application.

Rapierstar StarTurn™ screws offer up to 50% quicker drive-in time, with up to 50% lower torque - without pre-drilling.



What nails do I need?



Product Thickness		Sub Floor Required		Nail Length
9 - 12mm	+	12mm	=	32mm
9 - 12mm	+	16mm	=	32 or 38mm
14 - 15mm	+	15mm	=	38mm
14 - 15mm	+	19mm	=	38mm
19 - 20mm	+	19mm	=	44mm
19 - 20mm	+	22mm	=	50mm
25 - 26mm	+	22mm	=	50mm



Primatech T Nails
38/50mm



Primatech L Nails
38/44/50mm



Primatech L Nails
32mm



Quick Start



Safe

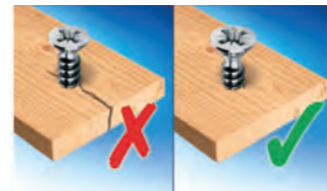

No Splitting & Low Torque



Superior Plating

StarTurn Screws	
5 x 30mm Pack size 200	6 x 40mm Pack size 200
5 x 40mm Pack size 200	6 x 50mm Pack size 200
5 x 50mm Pack size 200	6 x 60mm Pack size 200
5 x 70mm Pack size 200	6 x 70mm Pack size 200
5 x 100mm Pack size 100	6 x 100mm Pack size 100

How many nails do I need?

NOTE You can only nail your floor if you are installing over a wooden subfloor (not chipboard or concrete), as the nails need something to grip into. The nails will go into the tongued edge of the flooring plank at a 45 degree angle, so will be hidden from sight. This is why it is sometimes called 'secret nailing'.

$$\text{total m}^2 \div \text{face width of flooring} \div \text{joist centres} = \text{NAILS NEEDED}$$

EXAMPLE

$$20\text{m}^2 \div 0.083 \text{ (83mm width)} \div 0.30 \text{ (300mm centres)} = 804 \text{ NAILS}$$

Please **check the box size** when ordering fixings



Sales
Call 020 8501 6730
Delivering 6 days a week



*Subject to delivery terms

ORDERS FOR STOCK ITEMS PLACED BEFORE 3PM ON MACHINERY & ACCESSORIES

Standard Next Day - Business Hours **FREE** on orders over £150 +VAT
Standard Next Day - Business Hours **£10.00** +VAT on orders below £150 +VAT

EXPRESS DELIVERY COSTS

Next Day - Before 10.30am **£30.00** +VAT Before 12.00pm **£25.00** +VAT
Saturday - Before 10.00am **£40.00** +VAT

NOTE: The above prices exclude deliveries for RECLAIMED FLOORBOARDS, BATTENS - dependent on quantity, UNDERLAYS, PRO CARD, PLYWOOD, HARDBOARD AND SOME ADHESIVES. These products will be quoted per order due to either their size, weight or flammability properties.

NOTE Fixings that are priced per 1000 are sold in **VARIOUS** box quantities.
To confirm the current box quantity please speak to a member of our sales team.

Staples 90 Type		Unit	Price
	19mm Staples	1000
	22mm "	1000
	25mm "	1000
	18mm Divergent Point Staples	1000
	22mm "	1000
	<i>Use with 90 Type Stapler - See page 73</i>		

Drill Bits		Unit	Price
	160mm SDS Bit Plus Hammer 6.5	Each
	160mm " 8.0	Each
	160mm " 10.0	Each
	210mm " 8.0	Each
	19mm Flat Wood Bit	Each
	22mm "	Each
	25mm "	Each

Nails - Various		Unit	Price
	(1) 19mm Concrete Nails - 1kg Tub	Each
	25mm "	Each
	(2) 40mm Lost Head Nails - 0.5kg Bag	Each
	50mm "	Each

Please **check the box size** when ordering fixings

16G Brads		Unit	Price
	25mm 16 Gauge Brads/Finish Nails	1000
	32mm "	1000
	38mm "	1000
	50mm "	1000
	64mm "	1000
<i>Use with 16G Brad Nailer - See page 73</i>			
	25mm 16 Gauge Angle Brads/Finish Nails	1000
	32mm "	1000
	38mm "	1000
	45mm "	1000
	50mm "	1000
<i>Use with 16G Angle Brad Nailer - See page 73</i>			





Stainless Steel Headless Pins		Unit	Price
	15mm Stainless Steel Headless Pins	1000
	18mm "	1000
	22mm "	1000
<i>Use with 23G Headless Pinner - See page 73</i>			

Super Hardened T Masonry Nails		Unit	Price
	25mm Super Hardened T Masonry Nails	1000
	38mm "	1000
	50mm "	1000
	64mm "	1000
<i>Use with Multi Nailer - See page 73</i>			



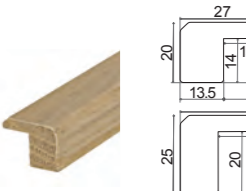
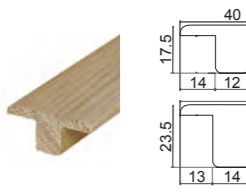
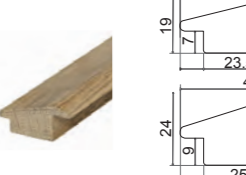

Mini Head Hardened T Nails		Unit	Price
	18mm Mini Head Hardened T Nails	1000
	25mm "	1000
	35mm "	1000
	40mm "	1000
	50mm "	1000
<i>Use with Multi Nailer - See page 73</i>			

All prices are per linear m unless stated

- Can't see the species you are after? **Please ask.**

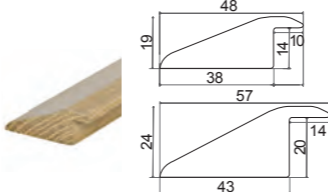
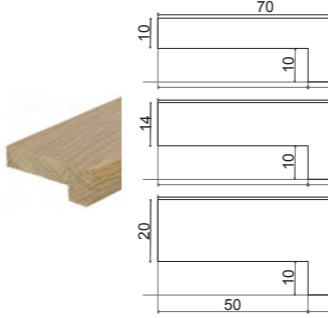
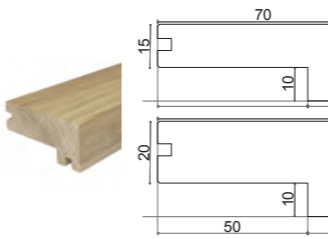
Hardwood Mouldings	Finish	Price/m
 MDF 16.5 x 16.5mm 2.4m lengths	<i>Wrapped</i> White	
 Scotia 16 x 16mm 2.9m lengths	<i>Unfinished</i> Oak	
 Scotia 19 x 19mm * 2.35m lengths 2.9m lengths	<i>Unfinished</i> Oak	
 Quadrant 19 x 19mm 2.9m lengths	<i>Unfinished</i> Oak	
 Flat Bead 25 x 6mm Flat Bead 44 x 6mm 2.9m lengths	<i>Unfinished</i> Oak	
 L Section 960mm / 2.9m lengths	<i>Unfinished</i> 14mm Oak	
 T Section 960mm / 2.9m lengths	<i>Unfinished</i> 14mm Oak	
 Reducer Wood to Tiles 960mm / 2.9m lengths	<i>Unfinished</i> 14mm Oak	

Hardwood & MDF skirting available to order

Hardwood Mouldings	Finish	Price/m
 Ramp 960mm / 2.9m lengths	<i>Unfinished</i> 14mm Oak	
 Bullnose Stair Nosing For 10mm Flooring For 14/15mm Flooring For 20mm Flooring All staircase nosings 960mm / 2.9m lengths	<i>Unfinished</i> Oak	
 Square Edge Stair Nosing For 14/15mm Flooring - rebated For 20mm Flooring All staircase nosings 960mm / 2.9m lengths	<i>Unfinished</i> Oak	
Hardwood Accessories	Finish	Price/unit
 Wooden Door Stop Floor or Wall Fixed	<i>Lacquered</i> Beech, Cherry, Oak, Walnut	
 12mm Snapable Wooden Pellets - Pack of 100	<i>Unfinished</i> Oak	
 16mm Dowled Radiator Pipe Ferrules - Deep - 15mm in depth	<i>Unfinished</i> Oak	
 15mm Snapable Radiator Pipe Ferrules - Slim Line - 4mm in depth	<i>Unfinished</i> Mahogany, Oak	

Approx Coverage 10-12m²/ltr unless specified

Bona[®]
Passion for wood floors



Bona White Primer 5ltr

Waterborne 1 component tinted primer used to create a 'white washed' look to a wood floor - ideal when creating a Scandinavian style interior! Combine with a Natural, Extra Matt or Matt Bona lacquer.



Bona Natural Primer 5ltr

Waterborne 1 component tinted primer. Overcoat with Mega Natural or Traffic Natural for the most natural, 'unfinished' look and a highly durable surface.



Bona Classic Primer 1ltr

Waterborne 1 component primer, for a classic, light wood look. Produces a well-bodied surface thanks to its high solids content. Non-yellowing.



Bona Classic Primer 5ltr

Waterborne 1 component primer, for a classic, light wood look. Produces a well-bodied surface thanks to its high solids content. Non-yellowing.



Bona Intense Primer 5ltr

Waterborne 1 component primer with a medium rich wood colouration. Suitable on practically all types of wood, especially on medium to dark species. Highly suitable for floors with underfloor heating.



Bona Amber Primer 5ltr

Waterborne 1 component rich, amber wood tinted primer. Highly suitable for floors with underfloor heating and/or moving floors such as end grain or plank floors.



Bona Nordic Tone 5ltr

Pre-treatment to using Bona Craft Oil (see page 127) for an intensively white floor. It inhibits wood yellowing and can be used on both softwood and hardwood.



Bona Rich Tone 5ltr

Pre-treatment to oak floors for creating a rich dark brown giving the impression of smoked oak.

Use with Bona Craft Oil see page 127.

Bona[®]
Passion for wood floors



Bona Mega

Gloss/Silk Matt/Matt/Extra Matt
1ltr is in stock in Silk matt only
Waterborne 1-component oil-modified topcoat, no mixing. Produces a subtle rich tone more noticeable on light wood.



Bona Mega ONE 5ltr

Silk Matt/Matt/Extra Matt
Waterborne 1 component polyurethane topcoat. Can be used with or without primer. Clear, non-yellowing formula. Brings out a nice, warm wood colouration.



Bona Mega Natural 5ltr

Waterborne 1 component polyurethane lacquer. Seals and protects recreating the look and feel of untreated wood. Produces a subtle rich tone more noticeable on light species or floors treated with light stains.



Bona Traffic HD & Hardener 4.95ltr

Silk Matt/Matt/Extra Matt
2 component, tough, fast drying, clear, non-yellowing lacquer for wooden floors exposed to extreme wear, allows full traffic after 12 hrs.



Bona Traffic Natural 4.95ltr

Unlike conventional lacquers the surface, to the touch, feels more like raw finely sanded wood, use to achieve the most natural looking surface. For best results combine with Bona Natural primer.



Bona Traffic HD Anti Slip & Hardener 4.95ltr

Matt
All the features of Bona Traffic HD but formulated for slip resistance in workplaces or kitchens where there is an increased risk of spills.



Bona Retarder 200ml

Designed to be used when the indoor humidity is low and/or the temperature of the room is higher than normal. This will reduce the risk of the lacquer drying too quickly and leaving roller marks in the dried coat.



Bona Traffic Replacement Hardener 400ml

Replacement hardener is the second component must be used in conjunction with Bona Traffic HD.

Approx Coverage 10-12m²/ltr unless specified



DG



Junkers BasePrime 5ltr

BasePrime is a quick-drying oil based primer. Excellent for wooden floors where water-based primers cannot be used due to poor adhesion, for example exotic and oily timbers. Gives the floor more depth of colour and should only be used directly on to bare wood.



Junkers High Performance Sport Lacquer 4.95ltr
Silk Matt

2 component waterbased 100% polyurethane lacquer for very high traffic sports floors. Suitable for previously sealed as well as on new or fully sanded floors. Non-yellowing, extremely durable, scuff resistant, and very fast curing.



Junkers PreLak Primer 5ltr

Fast drying, water-based primer for use on untreated or machine sanded wooden floors and to be used with other water-based floor finishes on internal timber floors. Can be used with Strong and HP Commercial.



Junkers High Performance Commercial Lacquer 4.95ltr
Ultra Matt/Matt/Silk Matt/Gloss

2 component, water-based polyurethane lacquer. For pre-finished or untreated, newly installed or machine sanded wooden floors in domestic and commercial areas with high levels of traffic and extreme wear.



Junkers PreLak 5ltr
White/Grey/Nordic

Fast drying waterborne primer for use with other water-based floor finishes on internal timber floors. Can be over-coated with any of the Junkers waterbased floor lacquers.



Junkers High Performance Friction+ 4.95ltr
Ultra Matt

Low-odour, hard-wearing water-based lacquer for wooden floor areas where a high level of slip resistance is required. Use as the final coat on floors treated with Junkers HP Commercial floor lacquer.



Junkers floor treatment programmes supply a broad range of lacquers, oils and cleaners, see page 144, ensuring the best treatment for your floor.



Junkers Strong Premium 5ltr
Matt/Silk Matt/Ultra Matt

1 component water-based, low odour lacquer for wooden floors in high traffic areas. Suitable for previously sealed as well as on new or fully sanded floors.



Junkers ProFinish 5ltr
Ultra Matt/Silk Matt

1 component water-based acrylic/polyurethane lacquer. For use on internal pre-sealed, new, or sanded old wooden floors. A quick drying and curing lacquer, suitable for light residential/ domestic levels of traffic.

DG



Junkers Professional 625 Lacquer 5ltr
Matt/Silk Matt/Gloss

2-component, quick-drying, acid curing lacquer for use on wooden floors in high traffic areas. Used on both previously sealed as well as on untreated or sanded floors.



Junkers Professional 625 Replacement Hardener 200ml

Call for discounts for volume orders over 12 bottles

Approx Coverage 8-10m²/ltr unless specified



Lobadur® WS Life 5ltr
Semi-Gloss
Waterborne 1 component finish for wooden floors. Elastic, stable properties for normal traffic, use after primer.



Lobadur® WS Viva 5ltr
Matt-Satin/Semi-Gloss
Waterborne 1 component finish. For normal to heavy traffic residential areas and light commercial use. Excellent for renovation, use after primer.



Lobadur® PrimaSealPlus 5ltr
Alcohol-based primer for wooden floors for all wood species. Intensifies the colour of the wood.



Lobadur® WS 2K Fusion 5ltr
Matt-Satin/Semi-Gloss
Waterborne 2 component polyurethane finish for wooden floors with extremely good final hardness. **PLEASE NOTE FOR THE UK:** Matt-Satin = Matt Semi-Gloss = Silk Matt



Lobadur® WS EasyPrime 5ltr
Polyurethane-acrylate waterborne primer for roller and trowel application, offers rapid drying. Suitable for virtually all types of European and exotic timber, sports and multipurpose halls.



Lobadur® WS 2K Fusion 5ltr Anti-Slip R9
Waterborne 2 component polyurethane finish for floors. Elastic, excellent chemical and abrasion resistance for heavy traffic, use after primer.



NEW
product call for details



Lobadur® Whitener 80ml
An additive that is added to water-based Lobadur® primers and finishes for a smooth brightening of wood floors. Suitable for all light wood species, preferably recommended for matt finishes.



250mm Microfibre Roller Sleeve 13mm Pile
Use with 2K Invisible Protect AT. See page 146 for CareCleaner.



Lobadur® 2K Invisible Protect AT 4.55kg
Waterborne surface protection for heavy traffic. Retains the natural appearance and feel of untreated wood. Use with 12mm Pile Roller (120g/m²). Coverage 8m²/ltr



Loba Measuring Jug
For mixing 2 part lacquer.
Loba Lacquer Bucket
Bucket with lid and measuring scale.



Sadolin PV67
Satin/Gloss
2 Part spirit based wooden bar top lacquer. Other areas of use include dance floors, restaurants, community halls, sports hall floors, shops and office flooring. Coverage 10-12m²/ltr



Shellac Base Polish 5ltr
Transparent spirit based sealer, use for a darker finish with most lacquers and waxes. Coverage 10-12m²/ltr



Shellac Base Polish White 5ltr
White spirit based sealer, virtually colourless once applied, use for a lighter finish with most lacquers and waxes. Coverage 10-12m²/ltr

Rollers and Handles
see page 137

Adesiv K32S Primer 10kg
Water-dispersion adhesion promoter. Suitable for absorbent surfaces or for non absorbent floors, to be applied before cement-based Adesiv Adecem Fiber.
Coverage approx 60-70m²

NEW product call for further details



Adesiv Adecem Fiber 25kg
Self-leveling fiber-reinforced cement-based powder for smoothing uneven substrates of thicknesses from 3 to 50mm. Suitable for underfloor heating. Coverage depends on the flatness of the surface.



ADESIV
since 1971 glues and varnish for parquet and more...



Adesiv WB PU 10kg
Single component PU DPM. 1 coat primer or 2 coats as DPM. Drying time 60 minutes. Apply kiln dried sand to final coat.
Coverage 2.5-5m²/kg



Ardex A 45 Repair Mortar Mix 11kg
Rapid drying and hardening, slump free mortar, hard enough to walk on and receive floors after 90 mins regardless of thickness.
Coverage approx 7m² at 1mm



Kiln Dried Sand 20kg
This sand is dried in a kiln which removes all the moisture, perfect to be used in conjunction with PU DPM's.



Screeding Trowel Soft Grip Handle
14in x 4in



Large Flexi Tub 42ltr
Extremely versatile and virtually indestructible. It can be used for mixing plaster or cement, moving rubble and various other jobs.



NEW product call for further details





Wakol MS330 Silane Primer and 10" Application Roller
Ready-to-use 1-component MS primer for priming absorbent and non-absorbent subfloors, and solidifying abraded or sanded screed edges.
Application and consumption*; Approx. 80 - 120g/m² - To harden surfaces when used as a primer use WAKOL Primer roller, short haired velour roller or rubber lip.
Approx. 250 g/m² - When used as a moisture barrier use WAKOL MS Special Roller - shown left and on page 135 - or trowel notch size according to TKB A2.
Primed surfaces can be walked on after approx. 60 minutes.
*Consumption is dependent on surface structure and absorbability of subfloor.



Wakol Z715 Levelling Compound 25kg
Level uneven sub floor with layer thickness of 1-10 mm unextended. Extended from 5-25 mm under parquet as of 2 mm layer thickness.
Coverage Approx 6m² at 3mm



Wakol AR114 Reinforcement Fibre 250g
Alkali-resistant glass fibres for reinforcing WAKOL Z715. Reduce cracking on unstable old subfloors, wood planks, wooden material tiles and prefab screeds.



Wakol PU280 Primer/DPM
Single component PU Resin Primer or a DPM when applied crosswise in two layers. Drying time 45 minutes.
Coverage 6-10m²/kg



Wakol D3055 Primer 10kg
Ready-to-use dispersion-based primer for all types of sub floors under all Wakol adhesives.
Coverage 8m²/kg



Wakol D3045 Primer 12kg
Ready-to-use single component 'aggregated' primer. Adhesion promoter for Z715 on PU280.
Coverage 8m²/kg



Wakol D3035 Primer 10kg
Ready-to-use primer for use on absorbent surfaces under the levelling compound.
Coverage 6m²/kg



Other types of matting available including logo matting **please call**



Approximately 80% of dirt in a building is introduced by footwear transported from outdoors. To help both protect and keep clean the solution is to lay protective matting.

See page 116 for L Section Molding.

Surcharges apply on all 'TO ORDER' matting • Next Day £25.00 • 5 Working Days £15.00

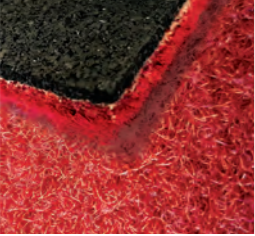
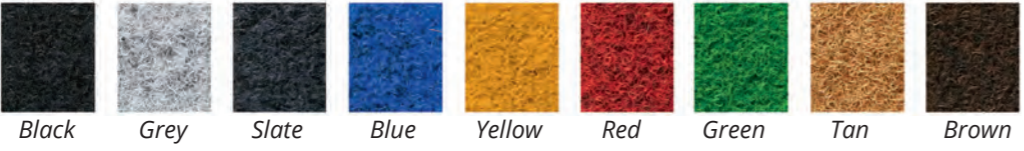
Matting	Width	Price/m ²
 <p>17mm Natural Coir Matting - IN STOCK</p>	1m	
	2m	
<p>17mm Coloured Coir Matting - TO ORDER</p>	1m	
		
 <p>9mm Coloured Ingenius Heavy Duty Matting - TO ORDER</p>	1m	
	2m	
		



Craft Oil 2K and Craft Oil available to order in sample pots please call.

- Great stain, water & wear resistance
- Spot repairable
- Intermixable colours
- Fast curing, floors ready for light use in 8 hours
- Compatible with tropical wood species
- Very low VOC content
- Compatible with other oils and colours from the Bona Oil System
- Application by squeegee, roller, trowel or buffing machine
- Overcoatable with Bona Traffic HD, Bona Traffic HD Anti-Slip and Bona Traffic Natural

Bona Craft Oil 2K 1.25ltr

Bona Craft Oil 2K's unique formula, made from modified plant based oil, delivers an accelerated drying time and great wear resistance. It's the perfect treatment for a wide variety of wood species including tricky ones such as cherry and walnut. Bona Craft Oil 2K produces a beautiful, strong water and stain-resistant surface that is ready for light use in just 8 hours. For enhanced durability, the oiled floor can be overcoated with any version of Bona Traffic lacquer if required, [see page 119](#), after just 12 hours. 12 colours are available as standard and each are intermixable.

	Ash		Dark Grey		Neutral Light
	Clay		Light Grey		Neutral Pure
	Frost		Old Grey		Sand
	Graphite		Invisible		Umbr



Bona Hard Wax Oil
Silkmatt/Matt

Very low in odour and easy to handle, and can be applied with roller, brush and trowel. Leaves an open, breathable surface that reduces the risk of side-bonding. Highly suitable for floors with underfloor heating. Free from cobalt and ketoximes. High coverage rate.



Bona Craft Oil

A natural vegetable oil, it has virtually no odour and significantly lowered VOC. Rapid drying and easy to apply.

	Ash
	Clay
	Frost
	Graphite
	Pure
	Umbr



Osmo Polyx High Solid Hardwax Oil
Matt/Satin/Gloss

	3062 Matt
	3032 Satin
	3011 Gloss



Osmo Polyx High Solid Hardwax Tints Oil
All the renowned properties of the original Polyx®-Oil, tinted for individual creativity. Polyx®-Oil Tints are water-repellent, dirt-resistant and durable. Microporous, breathable finish which does not crack, peel or flake. No sanding necessary for spot repairs or future applications. Protects and colours with wood grain visible.
Coverage 30m²/ltr/coat

	3040 White		3073 Terra
	3067 Light Grey		3074 Graphite
	3071 Honey		3075 Black
	3072 Amber		

DG *



Osmo Polyx High Solid Hardwax Oil Rapid
Matt/Satin

	3262 Matt
	3232 Satin

POA

Osmo Wood Wax Finish
Combining all the advantages of oils and waxes in one unique product. It is possible to create an almost infinite variation of naturally occurring colour shades to enhance the grain showing a gorgeous, natural colour tone or if you prefer a choice of intensive, bright or vivid colours. *Wood grain remains visible with transparent tones and can be hidden with intensive tones.* Very durable and hardwearing. Water and dirt resistant. No sanding necessary for spot repairs or future applications. Microporous, breathable finish which does not crack, peel or flake. For high tread surfaces when using the intensive colours only one coat is recommended, followed by a clear coat of Polyx®-Oil - **NOTE** characteristics become hidden as shown below if applying a second coat of Wood Wax Finish.

Transparent Tones		Intensive Tones	
	3101 Clear		3104 Red
	3102 Lightly Steamed Beech		3105 Yellow
	3103 Light Oak		3125 Blue
	3111 White		3131 Green
	3118 Granite Grey		3136 Birch
	3119 Silk Grey		3137 Cherry
	3123 Pine		3138 Mahogany
			3143 Cognac
			3161 Ebony
			3164 Oak
			3166 Walnut
			3168 Oak Antique
			3132 Grey Beige *
			3169 Black
			3172 Silk
			3181 Pebble
			3186 White, Matt
			3188 Snow

* Not available in 2.5ltr



Osmo Polyx High Solid Hardwax Oil Anti Slip
Semi-Matt Anti-Slip R9
Satin Anti-Slip Extra R11

	R9 3088 Semi-Matt
	R11 3089 Satin

available to order in sample pots



Osmo Polyx High Solid Hardwax Oil Effect Raw 2.5ltr
Raw/Silver/Gold
Coverage 30m²/ltr/coat

	3044 Raw
	3091 Silver
	3092 Gold



Osmo Oil Stain & Hardener
Colour and protect wooden floors without visible transitions, applying a single coat of the Oil Stain will create a transparent look showing the wood's natural grain, whilst an optional second coat can give a more intensive colour tone. A clear final coat of an Osmo Polyx®-Oil product is a must to protect pigmented finishes from wearing of colour.
Coverage 24-48m²/ltr/coat

Oil Stain Hardener 6631 is an optional second component, this can be used to harden the finish which reduces the drying and curing time from 12 to just 4 hours! *To Order.*

	3501 White		3519 Natural
	3512 Silver Grey		3541 Havanna
	3514 Graphite		3543 Cognac
	3516 Jotaba		3564 Tabac
	3518 Light Grey		3590 Black



Osmo Wood Wax Finish Clear Extra Thin
Natural oil and wax combined interior finish designed for hard, ingredient-rich, oily and dark wood species - such as Teak, Cedar, Iroko, Walnut etc.
 1101 Satin |



Osmo Polyx Oil Express & Hardener
Very fast drying, clear finish with special surface hardness and optional hardener 6632 for accelerated drying.

	3332 Satin
	3362 Matt



UV-Protection-Oil
Prolongs the renovation intervals significantly.

	410 Clear Satin without film protection
	420 Clear Satin with film protection
	425 Oak Tint



Osmo Polyx Oil 2K Pure 1ltr
Solvent and water-free 2-component oil developed for mechanical applications.
Coverage 40-50m²/ltr/coat
 6125 Clear Satin |

ACCESSORIES



Loba® HS 2K ImpactOil Color

2 component coloured HighSolid oil based on natural ingredients for staining of parquet and hardwood floors. Suitable for initial impregnating treatment of hardwood floors. Also suitable for rooms that are exposed to increased levels of moisture,

such as bathrooms, spa areas, etc. Anti-slip as per BGR 181 and DIN 51130 evaluation group R9. Due to its good penetration properties the wood will be preserved, but remains porous and breathable. Compared to regular 1C oils the 2C technology achieves a quicker curing, a lower susceptibility to dirt and a better water and chemical resistance.

Coverage 400 - 500 ft² per 2.5 kg unit for transparent oil where 1 coat is required. 150 - 250 ft² per per 0.75 kg unit for coloured oil with 2 coats, amounts depend on the absorbing properties of the wood.

	Black		Silver
	Chalk		Antique Oak
	Clay		Smoked Oak
	Iron		Sucupira
	Papyrus		Transparent
	Sand		Wenge



Loba® Markant Color or Transparent

Natural hardwaxoil for staining of parquet and hardwood floors. High-quality, layer-building oils accentuate the natural look of the wood and at the same time achieve excellent resistance to dirt and water. Suitable for virtually all types of European and exotic timber.

- Water and dirt resistant
- Film-forming, wear-resistant
- Accentuates the natural beauty of the wood
- Earliest possible overcoating after 12 hours
- Usable after 24 hours
- All variants can be mixed with each other
- Colours available in 0.75ltr only
- Transparent available in 0.75ltr and 2.5ltr - Satin or Matt



Coverage 20-100ml/m² depending on tool used

	Bilinga		Antique Oak
	Black		Smoked Oak
	Chalk		Sucupira
	Jatoba		Transparent
	Kambala/Iroko		Satin/Matt
	Mahogany		Wenge
	Papyrus		White



Junkers Rustic Oil Colour

Indoor priming and finishing oil product for untreated wooden floors. For areas with high levels of traffic and extreme wear then this can also be overcoated with HP Commercial, [see page 120](#). These oils emphasize the natural grain structure of the wood.

	Nut
	Walnut
	White

Coverage** 5-50 m²



Junkers Rustic Oil Clear

Satin finish, priming and finishing oil for wooden floors that can be used in combination with Rustic Oil Colour. Or, if you like the appearance of oil, but want the advantages of a lacquered surface, then you can combine Junkers Rustic Oils with Junkers HP Commercial lacquer.

**High and low traffic areas; 1 impregnating coat of Rustic Oil (5m² per litre), 2 thin coats of Rustic Oil (50m² per litre).

Coverage** 5-50 m²



Loba® ProColor Stain

For staining of parquet and hardwood floors. Dries reliably and lap-free, easily varnished over with LOBA® waterborne finishes. To lighten the shade or to reduce the coverage, mix with the transparent variant. Max. 3 parts transparent to one part colour. **NOTE** - All variants can be mixed with each other.

The below samples have been finished with 2 coats of Viva Silk. Coverage 20-33/m² depending on tool used

	Bilinga		Smoked Oak
	Black		Sucupira
	Jatoba		Transparent
	Kambala		Wenge
	Mahogany		White
	Papyrus		



Rustins Wood Dye Stain

This solvent based, fast drying stain for new bare/stripped wood does not raise the grain & must be over coated/sealed. All shades can be intermixed.

The below samples have been finished with a Satin Lacquer.

Coverage 24m²/ltr/coat depending on wood absorbency

	Antique Pine		Medium Oak
	Ebony		Dark Oak
	Grey		Light Teak
	Brown Mahogany		Dark Teak
	Red Mahogany		Walnut
	Light Oak		White*

* Water-based



Loba® PreTone Stain

Waterborne pigment stain for wooden floors. Colour intensification under colour oils. By accentuating the wood structure and grain, vibrant colour effects can be achieved.

Use on raw, carefully sanded wood. More intensive colour effects are achieved through the combination of water

and pigment, especially with light colour effects. When in combination with HS 2K ImpactOil Color the individual colour designs you are able to create becomes almost unlimited.

Coverage depends on application method

	Black		Steel
	Brown		White
	Mocha		



Mylands Non Fade Ground Stain



Solvent based stain available in a comprehensive selection of wood shades for professional use only.

The below samples have been finished with a Satin Lacquer.

Coverage Approx 20m²/ltr/coat

	Antique Pine		Medium Oak
	Bilinga		Warm Medium Oak
	Black		Dark Oak
	Kambala		Rosewood
	Brown Mahogany		Sapele
	Dark Mahogany		Teak
	Red Mahogany		Walnut
	Repro Mahogany		Dark Walnut

Sheet cutting charge 4 - 9mm £1.00 & 12 - 18mm £1.50 per cut

Plywood/Hardboard/Chipboard	Unit	Price
 <p>Hardboard 3mm 2.4m x 1.2m (8' x 4') Sheet</p>	Sheet	
 <p>WBP Plywood (only use with timber flooring) 3.6mm 2.4m x 1.2m (8' x 4') Sheet 5.5mm " " 9mm " " 12mm " " 15mm " " 18mm " " 25mm " "</p> <p>WBP Spruce Plywood (T&G) 18mm 2.4m x 0.6m (8' x 2') Sheet</p>	Sheet	
 <p>MR Chipboard (T&G) 18mm 2.4m x 0.6m (8' x 2') Sheet</p>	Sheet	

Sheet Count CALCULATION

customer area ÷ product area = SHEETS NEEDED



EXAMPLES

85m² ÷ 2.88 (Hardboard) = 30 SHEETS

165m² ÷ 1.44 (Chipboard) = 115 SHEETS

PRODUCT AREA CALCULATION = WIDTH x LENGTH

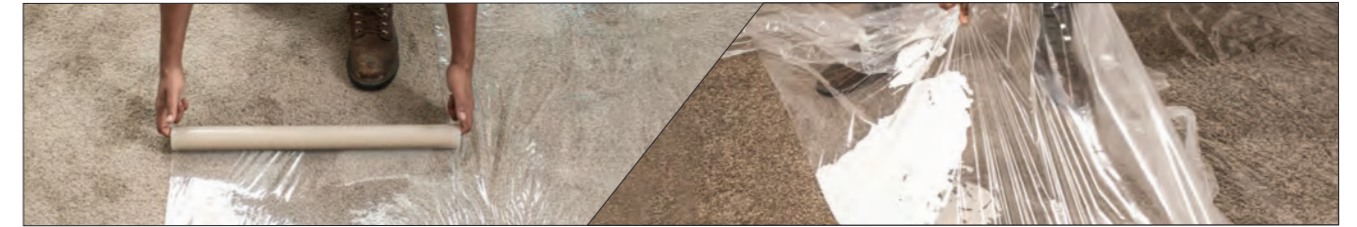
Always keep in mind do you need to order extra sheets?

Pro Carpet
600mm x 100m.
Clear polyethene with low tack acrylic adhesive.



Pro Card in 2 weights
300 Micron 100m²
550 Micron 50m² - heavy duty for use under the Pro Board (Corex).



Pro Dust Sheeting
4 x 25m
45 Micron 260G 100m²

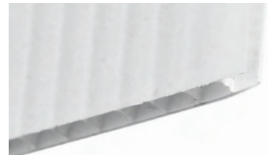

Pro Board (Corex) FR Euro
2.4 x 1.2m
Use to protect flooring.



High Tack Silver Cloth Tape Roll
50mm x 50m.



Masking Tape Rolls
50m rolls in either 25mm or 50mm.























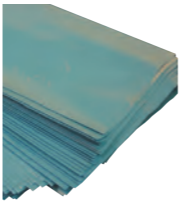

Frog Tape Delicate Masking Tape
41.1m rolls in either 24mm or 36mm.



Frog Tape Multi-Surface Masking Tape
41.1m rolls in either 24mm or 36mm.

ACCESSORIES

 <p>Loba Measuring Jug For mixing 2 part lacquer.</p>	 <p>Loba Lacquer Bucket Bucket with lid and measuring scale.</p>	 <p>Volcano Safety Goggles</p>	 <p>Jenkins Thinners 5ltr</p>	 <p>White Spirit 2ltr</p>	 <p>Stain Kettle 2.5ltr</p>								
 <p>Ear Defenders</p>	 <p>Max 101 Luxury FM-AM Ear Defenders</p>	 <p>Festool Digital Radio 230V or Battery Lightweight analogue or DAB digital radio.</p>	 <p>Paint/Lacquer Bucket and Liners Note: 10 Pack Liners are available for the 15ltr bucket only.</p>	 <p>Black PVC Bucket 13ltr</p>	 <p>Large Flexi Tub 42ltr</p>								
 <p>Flat FFP2 Dust Mask with valve</p>	 <p>1 Pair ABEK1P3 Filters Combination gas and particulate filter cartridges for JSP Force 8 half mask.</p>	 <p>JSP Force 8 Half Mask Complete with press to check P3 filters.</p>	 <p>Heavy Duty Rubbish Bags 500G 40 x 21"</p>	 <p>Replacement Bags Machine/Edger For all types of Machines.</p>	 <p>Overshoes 50 pairs</p>								
 <p>Tack Cloth Pack of 50</p>	 <p>Sand Pad/Sponge 100G</p>	 <p>Wire Wool DIY Pack 0/2/3</p>	 <p>Large Nitrile Gloves Box of 100 powder free large or x-large.</p>	 <p>Uniwipe Ultragrim Industrial Wipes 100 huge wipes - super soft, strong and absorbant with a unique grease-busting ability.</p>	 <p>Cork Expansion Strip</p> <table border="1"> <tbody> <tr> <td>22 x 12mm</td> <td>x 30</td> </tr> <tr> <td>14 x 10mm</td> <td>x 64</td> </tr> <tr> <td>10 x 10mm</td> <td>x 80</td> </tr> <tr> <td>12 x 8mm</td> <td>x 80</td> </tr> </tbody> </table> <p>Strips/box quantity is noted after the cost, prices are per strip.</p>	22 x 12mm	x 30	14 x 10mm	x 64	10 x 10mm	x 80	12 x 8mm	x 80
22 x 12mm	x 30												
14 x 10mm	x 64												
10 x 10mm	x 80												
12 x 8mm	x 80												



18" Padco Floor Coater
Available in 2 different weights.



24" Padco Floor Coater
Bigfoot heavyweight complete.



Padco Floor Trim Pad Set and Refill
Available in 2 sizes 8" and 10".



9" Short Pile Mohair Roller Sleeve
9 x 3/4" Wooden Handle Roller Cage



10" Handle and 10" Microfibre Roller Sleeve 13mm Pile
NOTE: Use with 2K Invisible Protect AT see page 123.



Roller Handle Adjustable 12 - 24"



Padco Nylfoam Refill
Blue sleeve (water based) For use with either Padco floor coater.



Padco Woven Refill
Yellow sleeve (spirit based) For use with either Padco floor coater.



Extension Pole
1.80m



4" Radiator Foam Roller & Tray Set



10" Osmo Roller Sleeve
Suitable for the application of all oil-based wood finishes.



Microstar Roller Sleeve
2 widths; 8mm microfibre on the 10" sleeve. 12mm microfibre on the 15" sleeve.
20% discount on 10 or more



300mm/12" Polish Applicator Frame
5ft Wooden Pole 23mm



Telescopic Microfibre Cleaning Mop Set
Includes the handle, swivel head and cleaning pad.



Microfibre Replacement Micro Fibre Pad



Professional Paint Brushes - Kana 50mm or 75mm Osmo 100mm
Suitable for the application of all oil-based wood finishes.



10" Green Acrylic Applicator Pad 18mm Pile
Great loading capacity for excellent coverage, suitable for rough surfaces.



Genuine Lambswool Applicator Pad



Bona Oil Cloth
Rip-resistant cotton cloths for oiling, cleaning and buffing jobs.
50 x 60 cm



Mutton Cloth 400G



Lacquer Tray



Osmo Double Blade Scraper 270mm
Use with Osmo Polyx Oils and Wood Wax Finishes. Double blade prevents flex reducing strain on hands.





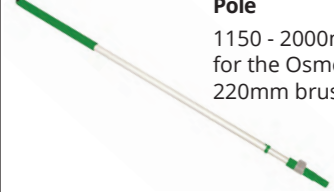

Osmo Brush 220mm
Made with 100% natural bristles and soft tips which gives fine control in achieving the desired effect. Attach to the Osmo Telescopic Pole.

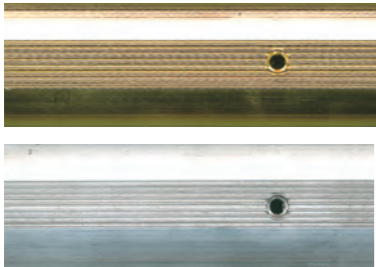

Osmo Telescopic Pole
1150 - 2000mm for the Osmo 220mm brush.

Full range of CAT trims available to order

Trims	Unit	Price
 <p>25mm 9mm</p> <p>Matwell Edging Gold 2.70 lin m Lengths..... Each.....</p> <p>Matwell Edging Silver 2.70 lin m Lengths..... Each.....</p>		
 <p>Naplock Single Gold 2.70 lin m Lengths..... Each.....</p> <p>Naplock Single Silver 2.70 lin m Lengths..... Each.....</p>		
 <p>Coverplate Gold 2.40 lin m Lengths..... Each.....</p> <p>Coverplate Silver 2.40 lin m Lengths..... Each.....</p>		
 <p>Formable Angle Trim - Mill Aluminium</p> <p>10mm (9mm Internal) 2.50m Length..... Each.....</p> <p>16mm (15mm Internal)..... "..... Each.....</p> <p>19mm (18mm Internal)..... "..... Each.....</p> <p>3mm</p>		

Product Code	Description	Price	
	EPR0-5..... 5m ² ECOFILMPRO KIT.....		
	EPR0-10..... 10m ² ECOFILMPRO KIT.....		
	EPR0-15..... 15m ² ECOFILMPRO KIT.....		
	EPR0-20..... 20m ² ECOFILMPRO KIT.....		
	CRIMP10..... 10 x Connection Clips.....		
	CTBL10..... 1.5mm ² x 10m Cold Tail Leads (Blue).....		
	CTBR10..... 1.5mm ² x 10m Cold Tail Leads (Brown).....		
	MASTIC1..... 101mm x 1m Mastic Adhesive Tape.....		
	GTD20..... 20 Green Bus Bar Insulating Disks.....		
Product Code	Description	Price	
	EL06..... ECOMAX-LITE Thermal Insulation (800mm x 1250mm).....		
	ADT50..... Heavy Duty Adhesive Tape (50mm x 50m roll).....		
	PVB12..... Polyester Vapour Barrier (1m x 12m)*.....		
	PVB25..... Polyester Vapour Barrier (1m x 25m)*.....		
	TH132AF..... Digital Programmable Thermostat.....		
<p>*1m x 12m of PVB has a floor coverage of 10m²</p> <p>**1m x 25m of PVB has a floor coverage of 20m²</p>			
Length in m	300mm wide element Element Ref Output w Price	500mm wide element Element Ref Output w Price	1000mm wide element Element Ref Output w Price
2.00	ES13-320.....70.....	ES13-520.....122.....	ES13-1020.....252.....
2.50	ES13-325.....88.....	ES13-525.....153.....	ES13-1025.....315.....
3.00	ES13-330.....105.....	ES13-530.....183.....	ES13-1030.....378.....
3.50	ES13-335.....123.....	ES13-535.....214.....	ES13-1035.....441.....
4.00	ES13-340.....140.....	ES13-540.....244.....	ES13-1040.....504.....
4.50	ES13-345.....158.....	ES13-545.....275.....	ES13-1045.....567.....
5.00	ES13-350.....176.....	ES13-550.....306.....	ES13-1050.....631.....
5.50	ES13-355.....193.....	ES13-555.....336.....	ES13-1055.....694.....
6.00	ES13-360.....211.....	ES13-560.....367.....	ES13-1060.....757.....
6.50	ES13-365.....228.....	ES13-565.....397.....	ES13-1065.....820.....
7.00	ES13-370.....246.....	ES13-570.....428.....	ES13-1070.....883.....
7.50	ES13-375.....263.....	ES13-575.....458.....	ES13-1075.....946.....
8.00	ES13-380.....281.....	ES13-580.....489.....	ES13-1080.....1009.....
8.50	ES13-385.....298.....	ES13-585.....519.....	ES13-1085.....1072.....
9.00	ES13-390.....316.....	ES13-590.....550.....	ES13-1090.....1135.....
9.50	ES13-395.....333.....	ES13-595.....580.....	ES13-1095.....1198.....
10.0	ES13-3100.....351.....	ES13-5100.....611.....	ES13-10100.....1261.....



3mm Wakol TS103 Sound Reduction Underlay 35m Roll

Cork/polyurethane foam matting for improving footfall sound and heat insulation.

Suitable as a soundproofing plate underneath: strip parquet, multi-layer parquet, solid wood planks.

35m x 1m x 3mm

Oak wood type, maximum 16cm in width.

Recommended adhesive PU225 see page 105.



Lecol TS160 Slotted Acoustic Underlay 3mm 15m² Roll

Slatted Underlay which has been coated on one side with aluminium. This prevents moisture from the subfloor permeating the underlay and entering the underside of the wood. The slats ensure the correct application of the MS262 adhesive see page 106.



3mm Heatflow 15m² Roll

1.37m x 11m

Sound Reduction up to 21db, use when installing engineered wood and laminate flooring over underfloor heating. Material is sponge rubber, lay white side up.

See page 139 for underfloor heating.



Bitumen Flooring Paper 25m² Roll

Use over joists with T&G Flooring BS1521. Breathable membrane, building paper each side of the bitumen. Use where the timber subfloor has a moisture content higher than the recommended 10-12% for installation e.g. if you are nailing over battens or timber joists.



Blu "All In One" Underlay 10m² Roll

Sound Reduction 20db - 3mm (10m²)

Integral damp proof membrane with joining tape. For wood, concrete and laminate floors. Excellent thermal and shock insulation qualities.

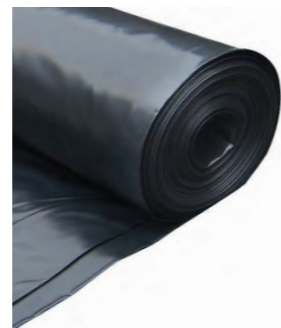

1000G DPM 100m² Roll

4m x 25m

Designed to be used in conjunction with a cushioning underlay, and to prevent moisture damaging the floor.

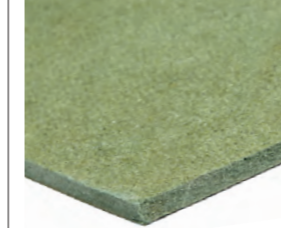

Fibre Boards 5.5mm 10.03m² Pack 7mm 9.6m² Pack

Fine Floor eliminates noise in rooms, limits heat loss through the floor and gives the impression of a "warm" floor. These natural wood fibre underlay insulating panels are used for laminate, engineered, and solid wood; domestic installations.



Regupol 4515 Eco Underlay 20m² Roll 3mm - 17dB 12m² Roll 4.5mm - 18dB

For concrete floors, material construction rubber/cork and can be bonded to all types of floors.

Suitable for underfloor heating.

Roll width 1.1m

See page 108 for acoustic solutions.



Technics Underlay 15m² Roll

Sound Reduction:-
5mm up to 28db
6mm up to 31db*

High quality reinforced crepe backing provides exceptional dimensional stability to the installation of wood floors.

*Available to order

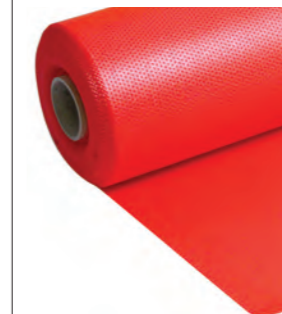

2mm Quick Therm Underlay 10m² Roll

Ultra low 0.35 Tog, perforated, very dense, closed cell polyethylene foam underlay - specially designed to offer maximum heat transfer for use with underfloor heating systems; for engineered and solid wood.

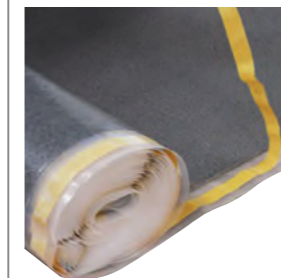

3mm Pro-tech Foam 10m² Roll

Sound Reduction up to 22db, (Inc 1000G DPM) takes out unevenness in the sub floor surface, full 1000 gauge damp proof membrane to both sides with integral joining tape.



4mm Duralay Timbermate Excel DIY Underlay 10m² Roll

Sound reduction underlay 23dB. Suitable for underfloor heating.

Timbermate Vapour Tape

75mm x 25m

Self adhesive seaming tape that creates a moisture barrier with improved joint seal protection and also strengthens underlay joints.



100% Passion, 100% Bona. Bona offers all the products you will need to clean and maintain floors finished with lacquer or oil.



Bona Starter Kit

Contains wood floor mop, microfibre cleaning pad and wood floor cleaner spray 1ltr.
Coverage up to 50m²/ltr



Bona Cleaner 5ltr

An everyday concentrated floor cleaner for all types of interior wooden floors. Used for regular mopping or in a machine based cleaning programme.
Coverage up to 2000m²/ltr



Bona Care Oil

Designed for the maintenance of oiled floors. Extremely low VOC and odour. It delivers superior protection due to its excellent penetration and is very quick drying.



Telescopic Microfibre Cleaning Mop Set

Includes the handle, swivel head and cleaning pad.

Replacement Microfibre Pad



Bona Telescopic Mop

Includes microfibre pad, this easy to manoeuvre, swivel mophead with telescopic handle works with all Bona Pads.



Bona Freshen Up 5ltr

Ready-to-use, waterborne maintenance coating for most finished and pre-finished floors. Revives a scratched and dull surface giving a newly finished look.
Coverage up to 50m²/ltr



Bona Polish Remover 1ltr

Removes build up from polish & other maintenance products. Important! Do not allow into open gaps in the floor. May cause permanent stain.
Coverage up to 50m²/ltr



Bona Refresher 1ltr

Ready-to-use, waterborne maintenance coating for varnished floors. It revives scratched and dull surfaces Important! Do not use on waxed or oiled floors.
Coverage up to 50m²/ltr



Bona Spray Cleaner and Refill

Ready-to-use and specially developed for cleaning of varnished or hard-waxed wooden floors. Spray-on cleaner, pH neutral, leaves no dulling residue.
Coverage up to 50m²/ltr



Bona Polish Gloss

Ready-to-use, waterborne maintenance coating for varnished floors. Gives the surface new lustre and continued protection.
Coverage up to 50m²/ltr



Bona Polish Matt

Ready-to-use, waterborne maintenance coating for varnished floors. Protects matt floors without drastically increasing the gloss level.
Coverage up to 50m²/ltr



Bona Microfibre Pad Refresher

Designed for the application of Bona Wood Refresher and all Bona polishes on all surfaces. Washable and reusable and attaches to the Bona Mop with Velcro-like strips.



Bona Microfibre Pad Cleaner

For use with Cleaner, this pad is a washable microfibre pad which attaches with Velcro-like strips to all Bona Mops, including the Bona Spray Mop.



Clear Plastic 1ltr Bottle with Spray Trigger



Bona Dusting Pad

For use with the Bona Standard or Spray Mop for dry mopping. Machine washable.





Osmo Wash and Care
 Concentrate for the everyday cleaning and maintenance of oiled and waxed wooden flooring.
 1 cover cap per litre of water



Osmo Maintenance Kit
 Contains Osmo Wash and Care for regular cleaning, Liquid Wax Cleaner for occasional intensive cleaning and refreshing. Maintenance cloths and instructions are also included.



Osmo Intensive Cleaner
 The ideal alternative to sanding wood surfaces finished with oils and waxes, use for intensive cleaning and restoration.
 Coverage up to 30-100m²/ltr



Clear Plastic 1ltr Bottle with Spray Trigger



Junckers SylvaCleaner
 SylvaCleaner is a universal cleaning product for daily or periodic cleaning of lacquered and oiled wood floors. SylvaCleaner has been developed to dissolve surface dirt and to dry quickly. Use a scrubber-dryer machine or clean by hand.
 Dilute 50–200 ml per 10 litres of water



Junckers SylvaNeutralizer 1ltr
 Use to neutralize SylvaCleaner before re-lacquering or to maintain slip resistance.
 The product also removes grease from wooden sports floors. It is not necessary to clean the floor with water afterwards .
 Dilute 200ml to 10ltr of water



Wood needs care and protection.
 The best product for wood is a finish that is developed only for wood, so you can enjoy your wood for a long time. With just one tin of Osmo you can achieve near to double the square meter coverage of an ordinary finishing system, saving you time and money.
 The foundation of Osmo wood finishes has been based upon purified and refined natural resources which are carefully harvested natural oils and hard waxes.



Osmo Maintenance Oil 1ltr
 3079 Matt 3081 Satin
 3440 White Transparent
 Ideal for the maintenance of solid wood, plank, parquet and strip treated with Polyx®-Oil.
 Coverage up to 40-60m²/ltr



Osmo Maintenance Oil Anti Slip (R9) 1ltr
 3098 Semi-Matt
 Ideal for the maintenance of solid wood, plank, parquet and strip treated with Polyx®-Oil.
 Coverage up to 40-60m²/ltr



Osmo Liquid Wax Cleaner 0.4ltr
 Clear Spray
 Ideal for removing tough stains and best suited for refreshing all surfaces treated with Osmo Polyx®-Oil.
 Coverage up to 80-100m²/ltr



Osmo Brush Cleaner 1ltr
 Perfect for use on paint brushes after use with wood finishes to remove the finish from the bristles. Can also be used a thinning agent for solvent-based finishes, such as Osmo's range of wood oils.



Osmo Liquid Wax Cleaner 1ltr
 3087 White
 Same spec as Clear 3029 other than **ONLY** to be used on white coloured/treated surfaces.
 Coverage up to 80-100m²/ltr



Osmo Liquid Wax Cleaner 1ltr
 3029 Clear
 Ideal for removing tough stains and best suited for refreshing all surfaces treated with Osmo Polyx®-Oil.
 Coverage up to 80-100m²/ltr



NO bucket required
Fast and easy cleaning



Lobacare® Spray Mop, Pad and Cleaner
Integrated Spray System for the cleaning of parquet and hardwood floors.
- No Bucket Required



Lobacare® Cleaner 1ltr
Daily cleaning for lacquered and oiled floors.
Use on all parquet, cork and multi-layer parquet flooring. Highly concentrated and specially developed for the LOBACARE® line of maintenance products but compatible with all floor-care systems.



Lobacare® Spray Mop Microfibre Replacement Cover
Microfibre mop cover replacement for use with the Loba Spray Mop. Used for cleaning wood and cork floors.



Lobacare® V6 Finish 1ltr
Matt/Gloss
Permanent polyurethane floor care for lacquered floors.
Matt - Suitable care product for extra-matt and matt-finished hardwood floors, cork floor coverings and more.
Gloss - Suitable care product for semi-matt and glossy-finished parquet, hardwood floors, cork floor coverings and more.



Lobacare® ParkettCare 1ltr
Waterborne floor care maintenance product for lacquered floors.
Suitable care product for matt and extra-matt-finished parquet and hardwood floors. Also ideal for UV-finished surfaces.



Felt Gard Plus 8 pack
25mm Nail In Felt Pads
Once hammered into the base of the furniture the felt covered pad is fixed in place and will then protect the flooring.



Kingston Felt Strip 1 pack
90 x 164mm
Soft, self adhesive, non marking and easily cut to size required. Helps to protect floors from dents and scratches. Before installation prepare surface by cleaning and lightly sanding to ensure better adhesion of the pads.



Kingston Felt Pads Multipack
19mm/26mm/38mm
Kingston Felt Pads are self-adhesive and help to protect floors from dents and scratches. Before installation, prepare surface by cleaning and lightly sanding to ensure better adhesion of the pads.



Kingston Felt Pads 32 pack
19mm
Kingston Felt Pads are self-adhesive and help to protect floors from dents and scratches. Before installation, prepare surface by cleaning and lightly sanding to ensure better adhesion of the pads.



Kingston Felt Pads 16 pack
26mm
Kingston Felt Pads are self-adhesive and help to protect floors from dents and scratches. Before installation, prepare surface by cleaning and lightly sanding to ensure better adhesion of the pads.



Kingston Felt Pads 8 pack
38mm
Kingston Felt Pads are self-adhesive and help to protect floors from dents and scratches. Before installation, prepare surface by cleaning and lightly sanding to ensure better adhesion of the pads.

1 DEFINITIONS

The Company means Wood Floors & Accessories Limited.

The Customer means the Customer of the Company.

The contract means the sale of goods between the Company and the Customer.

The goods mean the parts and materials sold from the Company to the Customer.

2. PRICES

Printed prices are subject to VAT and correct at the time of release but are subject to change without prior or written notice.

3. QUOTATIONS

All quotations are valid for 14 days and are subject to current stock availability from our suppliers.

4. DELIVERY

Adequate labour must be provided by the Customer at time of unloading of goods and will only be delivered to ground floor entrances and not unloaded into the premises.

All delivery dates quoted are approximate and the Company may not be liable for any costs incurred due to late deliveries.

Risk of the goods is passed to the Customer once they have been delivered.

5. STORAGE

The Customer shall store the goods in accordance with the British Standard Institute recommendations, unless otherwise stated.

6. CLAIMS & NOTIFICATIONS

Any claims for non delivery must be notified in writing to the Company within 24 hours.

Any claim that the goods were delivered damaged must be noted on the delivery note and notified in writing to the Company within 24 hours of delivery.

Any claims for the incorrect quantity being delivered must be notified in writing to the Company within 24 hours.

The Company will only accept responsibility for the first 1m²/Pack/Sheet/ Unit of sale of any product rejected due to poor quality and not an entire quantity.

The Company must be given the opportunity to investigate via a third party consultant any complaint regarding defective goods. In the event of a valid complaint the Company must be given the opportunity to replace the goods with an alternative batch or product and will not be liable for any costs incurred unless prior approval of quotations have been given in writing by the Company.

The Company has no liability for any kind of defects resulting from wear and tear, accident or improper use of the products supplied.

7. RETURNS & CANCELLATIONS

Stock products returned in their original condition will be subject to a 10% re- stocking charge to cover internal costs.

Certain products must be returned within 7 days and have matching batch numbers to those taken.

Any non stock products may be returned, at management's discretion, and will be subject to the manufacturers re-stocking fee.

Any bespoke products ordered will be subject to a 50% non refundable deposit and 100% cancellation charge.

Any incurred carriage costs will be quoted and charged at cost prices.

8. MOISTURE CONTENT, PRODUCTION & GRADING

The moisture content of any wood supplied by the Company will be in accordance with the British Standard Institute recommendations unless otherwise stated.

Any complaints as to the moisture content must be made in writing to the Company within 24 hours of delivery.

Any goods delivered by the Company must be stored in dry conditions in accordance with the British Standard Institute recommendations unless otherwise stated.

Grading rules may vary from country to country and manufacturer to manufacturer. Please check at time of placing an order for a certain product/range.

Production tolerances may vary from country to country and manufacturer to manufacturer but will generally be + - 1mm on the widths and + - 0.50mm on the lengths.

9. SAMPLES

All samples given by the Company to the Customer should only be used as an indication of colour and not as a true representation of the size, colour and grade of the product.

10. BESPOKE FINISHING

Although every effort is taken to control our finishing processes samples should be used as a general guideline to the final colour and shades. As natural tannin levels may vary from tree to tree the colours achieved in our smoked finishes enhance the inherent variation that nature dictates.

Bespoke finished orders are subject to a 100% cancellation charge and non returnable. We recommend a minimum 10% is allowed for selection waste on site and more should you require more consistency of colour.

All prices are correct at the time of going to press and are subject to vat at the current rate.

Please note that colour representation is not entirely accurate and is for guide purposes only.

Products not included in the delivery pricing structure due to either their size, weight or flammability properties include reclaimed floorboards, softwood battens - *dependent on quantity*, some underlays, pro card, plywood and hardboard.  In line with Environmental Legislation ISO14001, delivery charges are now POA only on products over 5kg per unit which are classed as hazardous goods.



WOOD FLOORS
& ACCESSORIES

CALL 020 8501 6730

info@wfa.uk.net • www.wfa.uk.net

Spilsby Road • Harold Hill • Romford • Essex • RM3 8SB



The mark of
responsible forestry